

# GHOST 100

Electromechanical underground automation for swing gates  
up to 3,5 m - 400 kg



For residential and  
collective usage



Available in 230V, 24V and  
with encoder technology



# GHOST 100



Leaf opening up to 180° with art. 116GN

The motor is supplied with 8m power cable to facilitate the electrical connection to the control panel

**Motor body compatible with speakers of other brands**

The one-piece aluminum motor body guarantees maximum watertight integrity



Built-in mechanical stops as standard to eliminate the need for floor stops



The standard foundation box with cataphoresis treatment guarantees excellent resistance to atmospheric agents. Stainless steel case also available for high salinity conditions



The DE@NET external universal control board make this operator compatible with the NETLINK system.

p.11



Compatible with NETCOM, the device for installation maintenance and remote control management



## Models

### 230V ~ operators without control board, with mechanical stops



COD.	Art.			OTHER CHARACTERISTICS
621252	100/CL			• Underground operator with connection lever, mechanical stops and complete with 8m of cable
621253	100EN/CL		✓	• Underground operator with connection lever, mechanical stops, encoder and complete with 8m of cable

**All models:** foundation box not included. Mechanical limit switches included. Motor cable L = 8m.  
**Control board to complete the installation:** control board cod. 677610 art. NET230N/C (with box)

### 24V = operators without control board, with mechanical stops



COD.	Art.		OTHER CHARACTERISTICS
621262	100/24CL		• Underground operator with connection lever, mechanical stops, encoder and complete with 8m of cable

**All models:** foundation box not included. Mechanical limit switches included. Motor cable L = 8m.  
**Control board to complete the installation:** control board cod. 678261 art. NET24N/C (with box)

## Technical info

TECHNICAL INFO	100/CL - 100EN/CL	100/24CL
Motor power supply (V)	230V ~ ± 10 % (50/60 Hz)	24V =
Maximum power absorption (W)	250	50
Max torque (Nm)	250	200
Duty cycle (cycles/hours)	18 - 25 (vers. 100EN)	40
N. max cycles in 24h.	100	
Built-in capacitor (µF)	10	/
Operating temperature (°C)	-20 ÷ 50	
Motor thermal protection (°C)	150	/
90° Opening time (s)	16	14
Weight with packing (Kg)	11	
Sound pressure (dBA)	< 70	
Protection level	IP67	

## Example of a typical installation

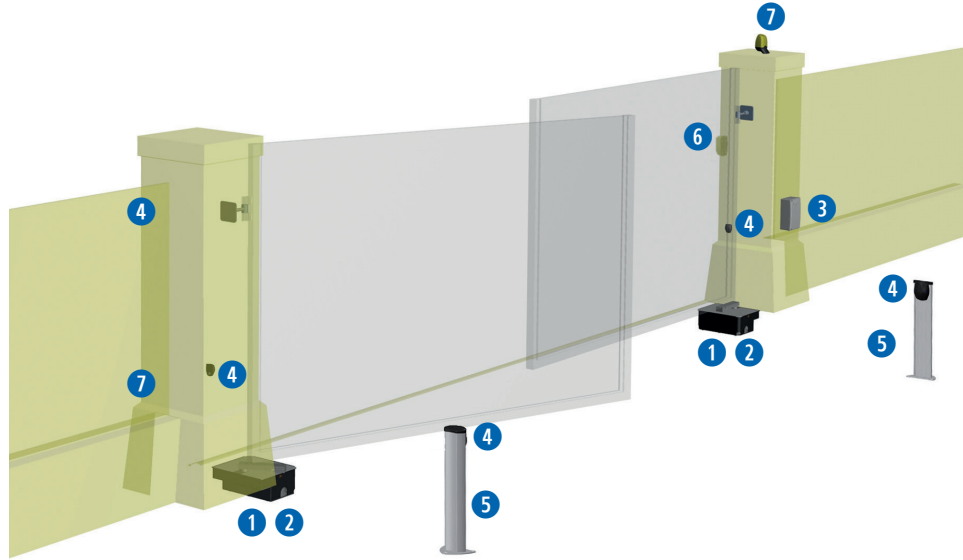

**KIT**

**1**

**COD. 621253**  
**Art. 100EN/CL**  
Electromechanical underground operator for swing gates

**KIT**

**2**

**COD. 629000**  
**Art. 215**  
Foundation box with cataphoresis treatment complete with gate support and unlocking device

**KIT**

**3**

**COD. 677610**  
**Art. NET230N/C**  
Universal digital control board for 1 or 2 operators, 230V with or without magnetic encoder (with box)

**KIT**

**COD. 662080**  
**Art. LINEAR/XS**  
Pair of mini synchronizable photocell for outdoor installation. Maximum range 20m

**5**

**COD. 664000**  
**Art. PILLY/60**  
55cm column for photocell (2 pcs)

**6**

**COD. 663090**  
**Art. GT-KEY**  
Metal vandal proof keyswitch with two contacts, surface mounted. Supplied with 2 keys.

**KIT**

**COD. 661130**  
**Art. AURA N**  
Multi-voltage LED flashing light 24AC-DC / 120AC / 230AC and with integrated 433MHz / 868MHz antenna

**NEW**

**KIT**

**COD. 672645**  
**Art. GTI4**  
Serialized white 4-channel remote control, 433 MHz, with 3 coding: HCS Rolling-Code, Dip-Switch and new D.A.R.T. coding

**COD. 668010**  
**Art. 127**  
Warning sign

**KIT** for further details on the kits see price list

## Specific accessories

**COD. 629000**  
**Art. 215**  
Foundation box with cataphoresis treatment complete with gate support and unlocking device

**COD. 629010**  
**Art. 215I**  
Stainless steel foundation box complete with unlocking mechanism

**COD. 629022**  
**Art. 116G/N**  
Device to be fixed to art. 215 e art. 215I to obtain an opening angle of 180°

**COD. 629391**  
**Art. KIT ADAB**  
Adapter set for other foundation boxes dim. 410x330x145 mm

**COD. 629392**  
**Art. KIT ADA 115/C**  
Adapter set for foundation box art. 115, art. 115I

**COD. 629290**  
**Art. BAT**  
Rechargeable batteries kit for 24V operators, 12V - 1,2Ah, complete with wiring cables and fixing plate

**COD. ZZZZZZ**  
**Art. 118/XL**  
Additional reinforced limit switch for GHOST100 motor

**NEW**

## Guide to use

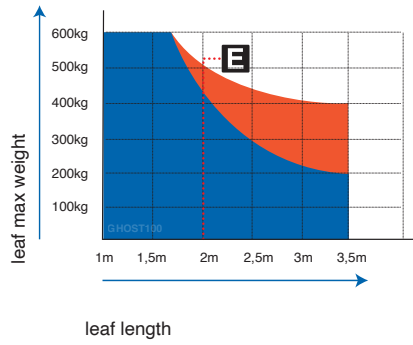
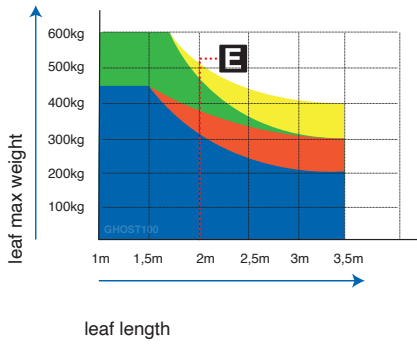

- = models with encoder and mechanical limit switches incorporated in the operator
- = models with encoder and mechanical stops on the ground
- = models with mechanical limit switches incorporated in the operator
- = models with mechanical stop on the ground

If the leaf length is bigger than 2m or if you use reversible models you must install the electric-lock to block the gate in closed position. The height and the leaf structure, as well as the presence of strong wind, can cause the reduction of the value of the data contained in table or make it necessary to use an electric lock also for leaves shorter than 2m.

## Wiring

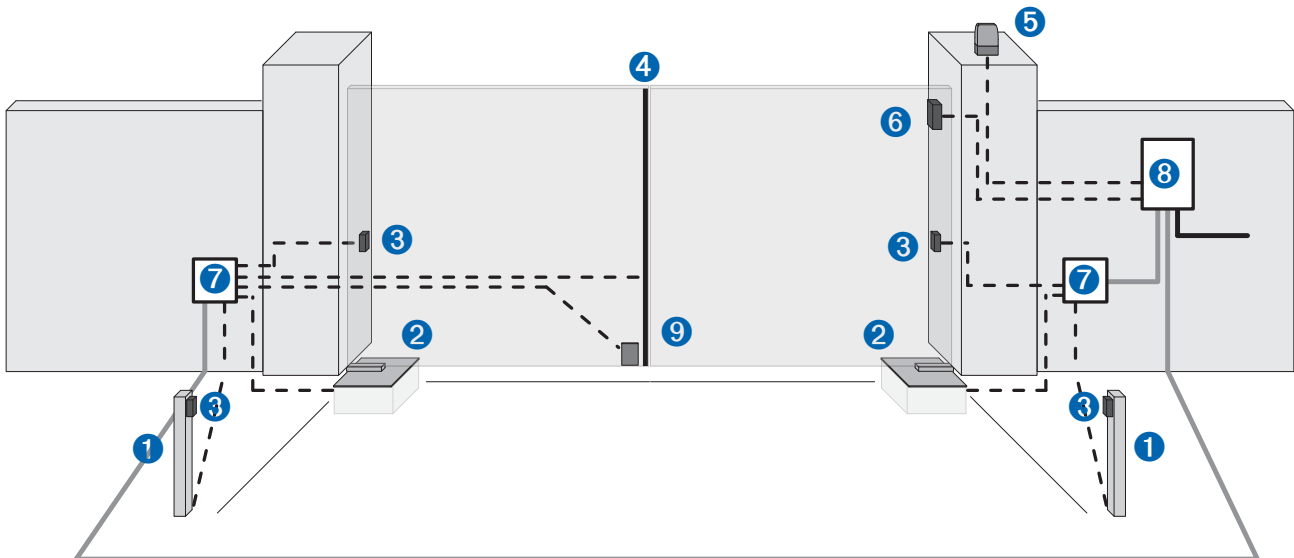

- Corrugated pipe for power supply cable
- Ø40 corrugated pipe for connection between the control board and the junction box
- - - Ø20 corrugated pipe or external PVC conduit for connection between the control board and the command and safety accessories

pos.	description
1	Column with photocells
2	Operator
3	Photocells
4	Safety edge
5	Flashing light
6	Key switch/Keypad
7	Junction box
8	Control board
9	Electric-lock

## Dimensions

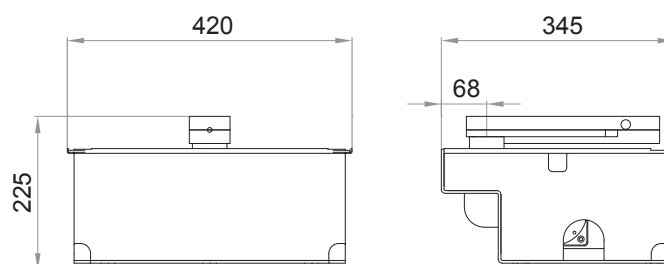



## What about the products? We make them ourselves!

We manage the whole production process.

We design, produce and assemble both the mechanic and electronic components of our products. This is crucial to guarantee the quality of each component, especially when technology is connected to people's safety.



## What about electronics? We also make it ourselves.



Each DEA product is totally conceived and developed in-house. DEA HT, a company that is a part of our group, designs and produces the electronic components controlling our automations.

# DEAuser



DEAuser is the app for **private users** that allows activation of automation at **close proximity** via Bluetooth.

By installing the NET-NODE on all devices with NETLINK technology, users can control their automations through their smart devices.

To be used with:



Art.NET-NODE  
Cod.677640

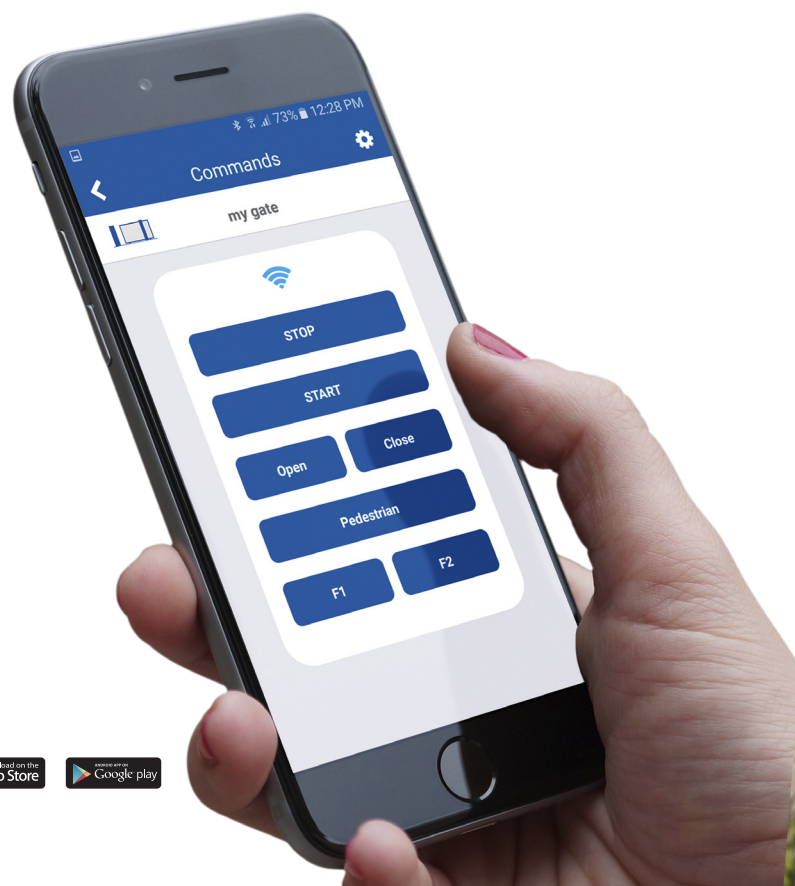



# DEAinstaller



DEAinstaller is the App dedicated to the **professional installer** and allows Installers to program and manage DEA automations on-site in a simple and intuitive way from their smart devices.

If you use it with the NET-NODE you can:

- ✓ keep a **data backup** of all installations
- ✓ easily adjust the **parameters** of control boards
- ✓ update the **firmware**
- ✓ program the **maintenance**
- ✓ manage or customise the **remotes**
- ✓ read **technical manuals** or have a look at the **electrical connections**
- ✓ control the **inputs** and **output** of the control boards
- ✓ **control** the automation with the App

To be used with:



Art.NET-NODE  
Cod.677640

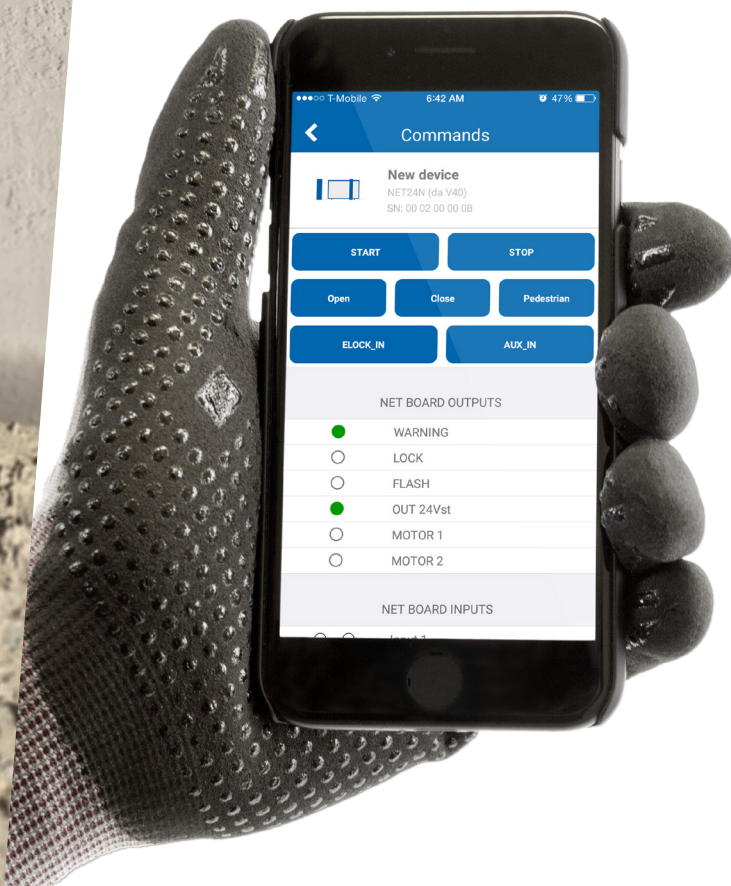

## Generic accessories



✓ 24V  
✓ 120V  
✓ 230V

**AURA N**

cod. 661130



**LINEAR XS**

cod. 662080



**LINEAR**

cod. 662044



**COVER/2**

cod.681060



**LINEAR SHIELD**

cod. 662047



**PILLY 60 -120**

cod. 664000 - 664010



**DIGIPRO**

cod. 663310



**DIGISLIM**

cod. 663311



**GT-KEY**

cod. 663090



**DIGIRAD**

cod. 663280



**BAT**

cod. 629290



**GTI2-GTI4**

cod. 672635 - 672645



**GTI2M-GTI4M**

cod. 672603 - 672613

## #safeasyoulike!

### Non-copyable remotes!

GTI remotes are multi-function. They have three coding possibilities: DIP SWITCH, Rolling Code and D.A.R.T. the new DEA advanced coding.

You can customise the code of the remotes to guarantee the maximum security to your customer.

**D.** DEA  
**A.** Advanced  
**R.** Rolling Code  
**T.** Transmission

Looking for **total safety**?  
With **NET-BOX** each installer can customise the code of your GTI remotes.



## #colourasyoulike!

### Choose your favorite colour!

GTI remotes can be customised with button kits in seven colours: green, light green, blue, pink, yellow, orange and purple.

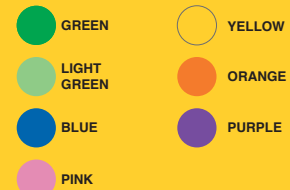

Note: button kits are supplied in packs of 5. The remote must be ordered separately.



# NETLINK

is our technology applied to DEA devices for the smart management of your installations, both **locally** and **remotely**.



## Our range

### Automations for sliding gates



LIVI N



REV



GULLIVER



### Automations for sectional doors



SPACE



ADVANCE



LIVI 902



### Automations for swing gates



MAC



STING



LOOK

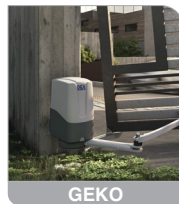

GEKO



LIVI 502



GHOST 100/200



OLI N



### Automations for industrial gates



LATO



550 PL



### Barriers



PASS



STOP



TRAFIK



### Bollards



ROCK



**HEADQUARTER**  
**DEA SYSTEM S.p.A.**  
 Via della Tecnica, 6 - 36013 Piovene Rocchette (VI) - ITALY  
 ☎ + 39.0445.55.07.89 - 📠 + 39.0445.55.02.65  
 info@deasystem.com - www.deasystem.com

**Branches >** Italia, France, United Kingdom, Ireland, España,  
 Portugal, Polska, Deutschland, Беларусь

**> HEAD OFFICE**  
**DEA GATE AUTOMATION Ltd.**  
 Sandholes Road - Cookstown - Co. Tyrone  
 BT80 9AR - IRELAND  
 ☎ + 44 (0)28 8676 6476 - 📠 + 44 (0)28 8676 2414  
 info@deagateautomation.com

**DEA GATE AUTOMATION Ltd.**  
 Unit 31 - The IO Centre - Hearle Way - Hatfield - Hertfordshire  
 AL10 9EW - UNITED KINGDOM  
 ☎ + 44 (0)17.07.24.65.99  
 info@deagateautomation.co.uk