

GHOST 200

Electromechanical underground automation for swing gates
up to 4 m - 400 kg



For residential and
collective usage



Available in 230V and 24V



GHOST 200

Operators available in fast or slow version, for greater safety during movement

Painted aluminum operator body for high corrosion protection

Leaf opening up to 180° with art. 216GN

The operator is supplied with 8m power cable to facilitate the electrical connection to the control panel



The external plate for mechanical stops (art. 218 - optional) eliminates the need for ground stops

The DE@NET external universal control board make this operator compatible with the NETLINK system.



Compatible with NETCOM, the device for installation maintenance and remote control management

The standard foundation box with cataphoresis treatment guarantees excellent resistance to atmospheric agents. Stainless steel case also available for high salinity conditions



Models

230V ~ operators without control board



COD.	Art.			OTHER CHARACTERISTICS
621040	200CL			<ul style="list-style-type: none"> Underground operator with connection lever and complete with 8m of cable
621013	200L/CL			<ul style="list-style-type: none"> Slow version (90°=26s) Underground operator with connection lever and complete with 8m of cable

All models: foundation box and limit switches not included.

Control board to complete the installation: control board cod. 677610 art. NET230N/C (with box)

For all models: cable L=8m

24V = operators without control board



COD.	Art.		OTHER CHARACTERISTICS
621050	200/24CL		<ul style="list-style-type: none"> Underground operator with connection lever and complete with 8m of cable

All models: foundation box and limit switches not included.

Control board to complete the installation: control board cod. 678261 art. NET24N/C (with box)

For all models: cable L=8m

Technical info

TECHNICAL INFO	200CL	200L/CL	200/24CL
Motor power supply (V)	230V ~ ± 10 % (50/60 Hz)		24V =
Maximum power absorption (W)	400	330	150
Max torque (Nm)	320	300	210
Duty cycle (cycles/hours)	20 - 28	18	40
N. max cycles in 24h.	200		280
Built-in capacitor (µF)	12,5		/
Operating temperature (°C)	-20 ÷ 50		
Motor thermal protection (°C)	150		/
90° Opening time (s)	17	26	16
Weight with packing (Kg)	14,5		14
Sound pressure (dBA)	< 70		
Protection level	IP67		



Operator with a steel worm screw and a bronze crown wheel lubricated with low viscosity grease guaranteeing a longer service life and a reduced wear



Emergency key-operated release (internal or external)

Example of a typical installation

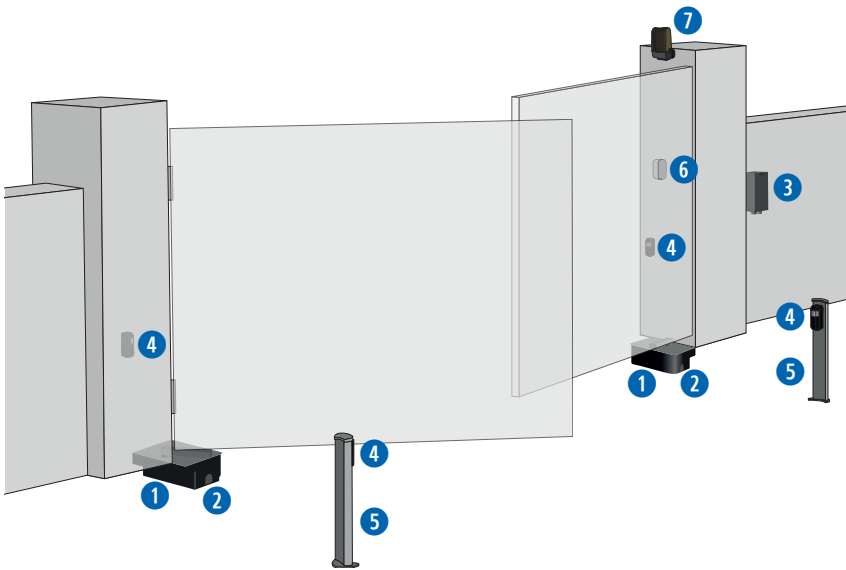

Dimensions

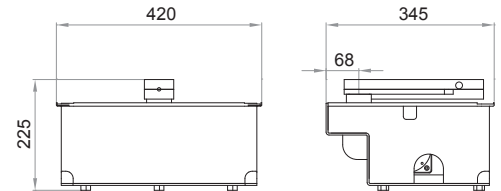

KIT

1 **COD. 621040**
Art. 200CL
Electromechanical underground operator for swing gates

KIT

2 **COD. 629000**
Art. 215
Foundation box with cataphoresis treatment complete with gate support and unlocking device

KIT

3 **COD. 677610**
Art. NET230N/C
Universal digital control board for 1 or 2 operators, 230V with or without magnetic encoder (with box)

KIT

4 **COD. 662080**
Art. LINEAR/XS
Pair of mini synchronizable photocell for outdoor installation. Maximum range 20m

5 **COD. 664000**
Art. PILLY/60
Pair of 55cm column for photocells (2 pcs)

6 **COD. 663090**
Art. GT-KEY
Metal vandal proof keyswitch with two contacts, surface mounted. Supplied with 2 keys.

KIT

7 **COD. 661130**
Art. AURAN
LED flashing light, multi-voltage 24V AC-DC/120V AC/230V AC, with integrated antenna 433MHz/868MHz

KIT

COD. 672645
Art. GTI4
Serialized white 4-channel remote control, 433 MHz, with 3 coding: HCS Rolling-Code, Dip-Switch and new D.A.R.T. coding

COD. 668010
Art. 127
Warning sign

KIT for further details on the kits see price list

Specific accessories

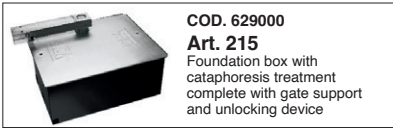

COD. 629000
Art. 215
Foundation box with cataphoresis treatment complete with gate support and unlocking device



COD. 629010
Art. 215I
Stainless steel foundation box complete with unlocking mechanism

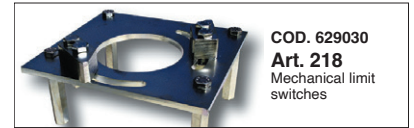

COD. 629030
Art. 218
Mechanical limit switches



COD. 629020
Art. 216
Device to be fixed into art. 215 e art. 215I to obtain an opening angle of 180°

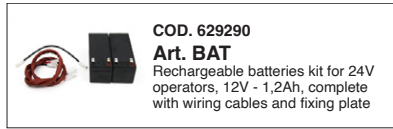

COD. 629290
Art. BAT
Rechargeable batteries kit for 24V operators, 12V - 1,2Ah, complete with wiring cables and fixing plate



COD. 330610
GHOST RELEASE KEY
Release key for GHOST

Guide to use

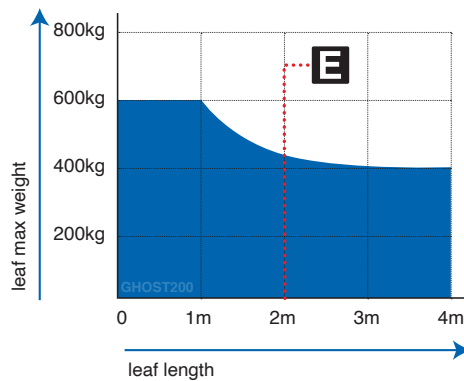

If the leaf length is bigger than 2m or if you use reversible models you must install the electric-lock to block the gate in closed position. The height and the leaf structure, as well as the presence of strong wind, can cause the reduction of the value of the data contained in table or make it necessary to use an electric lock also for leaves shorter than 2m.

Wiring

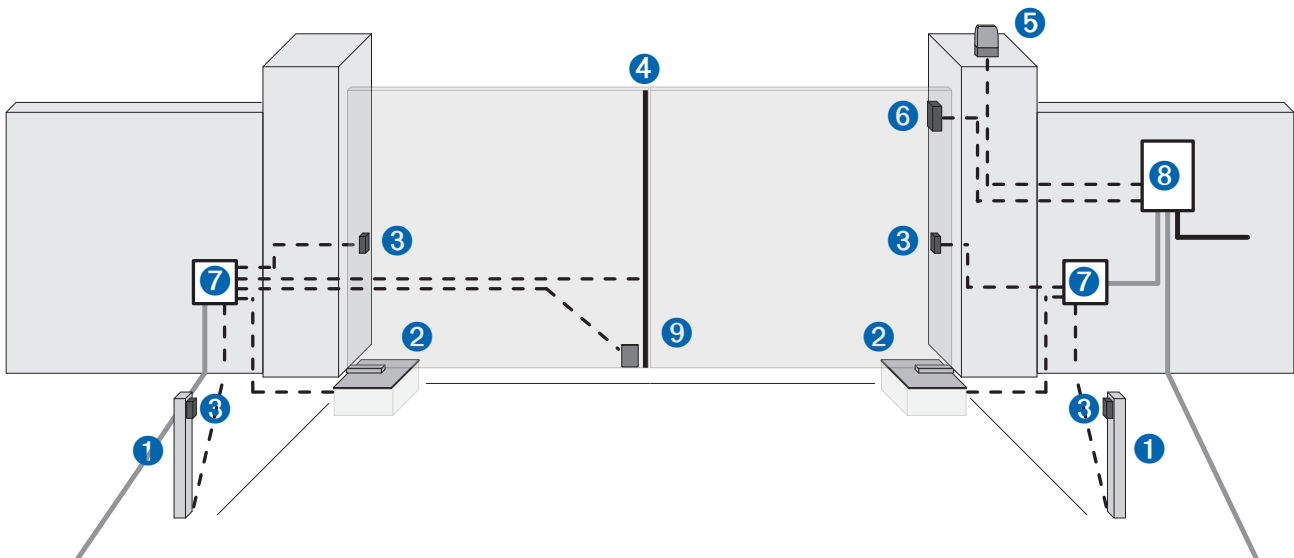

- Corrugated pipe for power supply cable
- Ø40 corrugated pipe for connection between the control board and the junction box
- - - Ø20 corrugated pipe or external PVC conduit for connection between the control board and the command and safety accessories

pos.	description
1	Column with photocells
2	Operator
3	Photocells
4	Safety edge
5	Flashing light
6	Key switch/Keypad
7	Junction box
8	Control board
9	Electric-lock



What about the products? We make them ourselves!

We manage the whole production process.

We design, produce and assemble both the mechanic and electronic components of our products. This is crucial to guarantee the quality of each component, especially when technology is connected to people's safety.



What about electronics? We also make it ourselves.



Each DEA product is totally conceived and developed in-house. DEA HT, a company that is a part of our group, designs and produces the electronic components controlling our automations.

DEAuser



DEAuser is the app for **private users** that allows activation of automation at **close proximity** via Bluetooth.

By installing NET-NODE on all devices with NETLINK technology, you can control your gate through your smartphone.

To be used with:



Art.NET-NODE 2.0
Cod.677642



DEAinstaller



DEAinstaller is the App dedicated to the **professional installer** and allows Installers to program and manage DEA automations on-site in a simple and intuitive way from their smart devices.

If you use it with the NET-NODE you can:

- ✓ keep a **data backup** of all your installations
- ✓ easily adjust the **parameters** of your control boards
- ✓ update the **firmware**
- ✓ program the **maintenance**
- ✓ manage or customise the **remotes**
- ✓ read **technical manuals** or have a look at the **electrical connections**
- ✓ control the **inputs** and **output** of the control boards
- ✓ **control** the automation with the App

To be used with:



Art.NET-NODE 2.0
Cod.677642

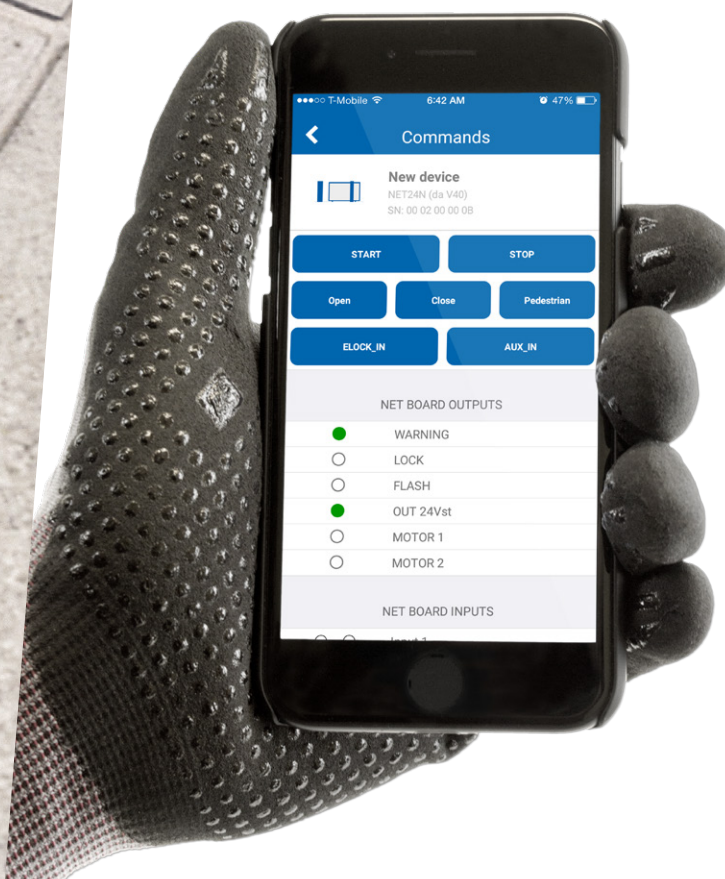

Generic accessories

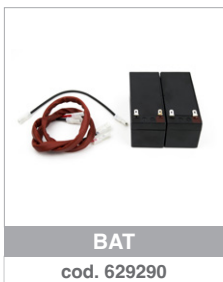
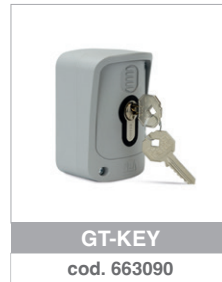
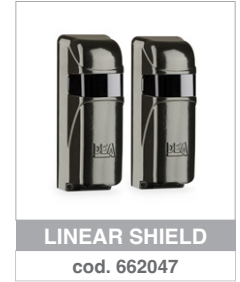

#safeasyoulike!

Non-copyable remotes!

GTI remotes are multi-function. They have three coding possibilities: DIP SWITCH, Rolling Code and D.A.R.T. the new DEA advanced coding.

You can customise the code of the remotes to guarantee the maximum security to your customer.

- D.** DEA
- A.** Advanced
- R.** Rolling Code
- T.** Transmission

Looking for **total safety**?
With **NET-BOX** each installer can customise the code of your GTI remotes.



#colourasyoulike!

Choose your favorite colour!

GTI remotes can be customised with button kits in seven colours: green, light green, blue, pink, yellow, orange and purple.



Note: button kits are supplied in packs of 5. The remote must be ordered separately.



NETLINK

is our technology applied to DEA devices for the smart management of your installations, both **locally** and **remotely**.



Our range

Automations for sliding gates



LIVI N



REV



GULLIVER



Automations for sectional doors

NEW

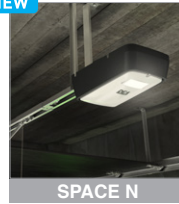

SPACE N



NEW



ADVANCE N



LIVI 902



Automations for swing gates

NEW



MAC



NEW



STING



NEW

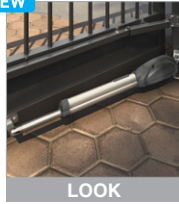

LOOK



GEKO



LIVI 502



GHOST 100/200



OLI N



Automations for industrial gates



LATO



550 PL



Barriers

NEW



PASS N



NEW



STOP N



TRAFIK



Bollards



ROCK



DEA
move as you like

HEADQUARTER
DEA SYSTEM S.p.A.
Via della Tecnica, 6 - 36013 Piovene Rocchette (VI) - ITALY
☎ + 39.0445.55.07.89 - 📠 + 39.0445.55.02.65
info@deasystem.com - www.deasystem.com

Branches > Italia, France, United Kingdom, Ireland, España,
Portugal, Polska, Deutschland, Беларусь

> **HEAD OFFICE**
DEA System UK & IRE
Sandholes Road - Cookstown - Co. Tyrone
BT80 9AR - IRELAND
☎ + 44 (0)28 8676 6476 - 📠 + 44 (0)28 8676 2414
info@deasystem.net

DEA System UK & IRE
Unit 31 - The IO Centre - Hearle Way - Hatfield - Hertfordshire
AL10 9EW - UNITED KINGDOM
☎ + 44 (0)1707 246 599
contact@deasystem.net