

RM-SERIES

Rackmount 100V mixer-amplifiers with Bluetooth®

Item ref: 953.213UK, 953.214UK, 953.215UK, 953.216UK

User Manual

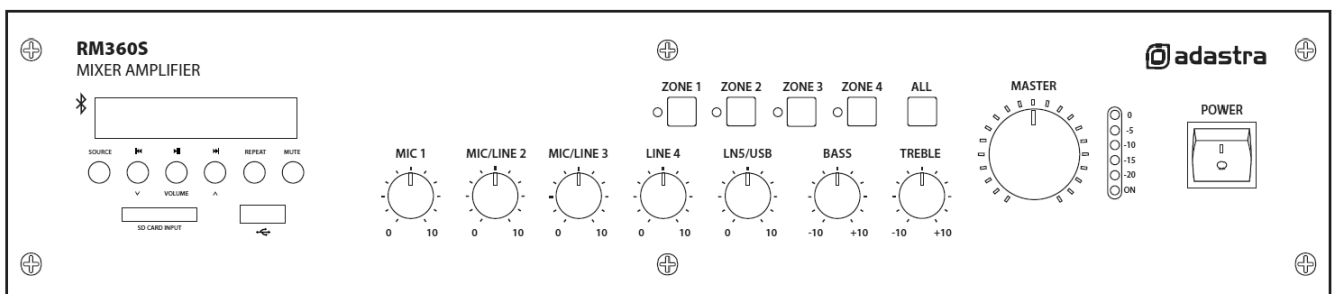
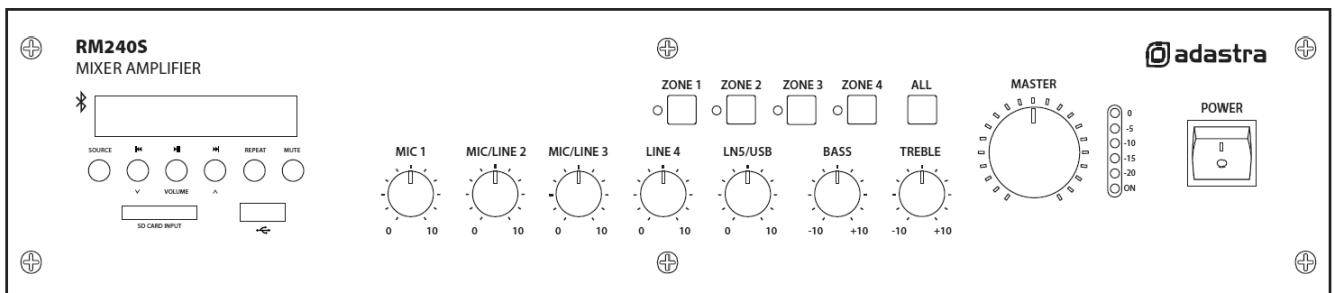
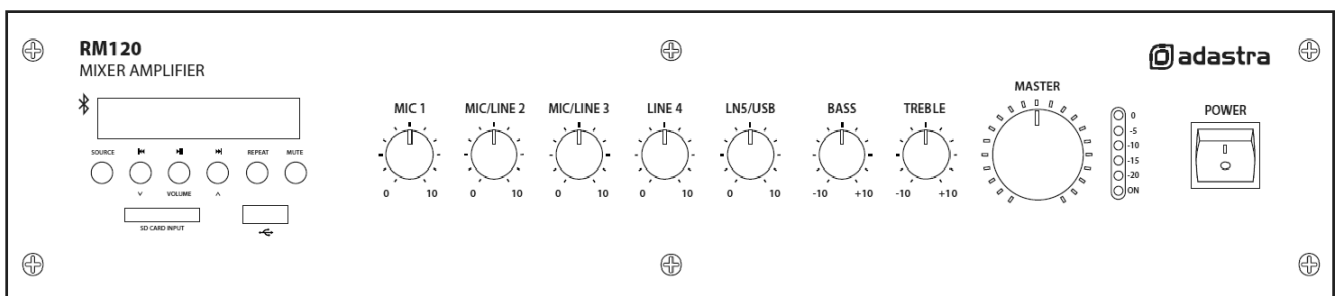
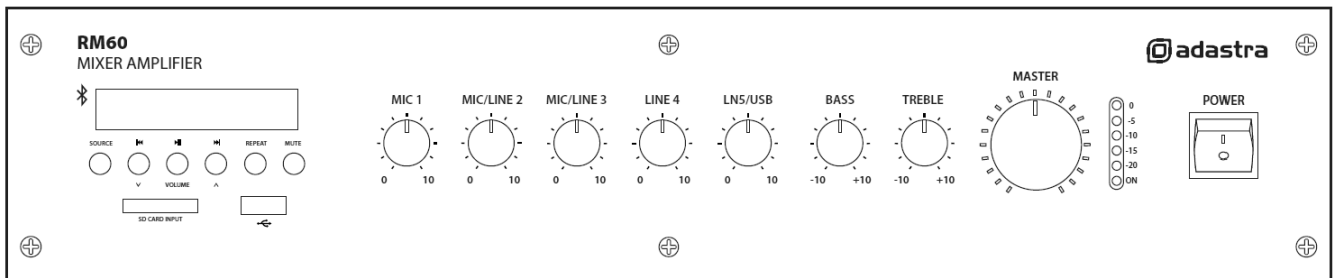

Version 3.1



Caution: Please read this manual carefully before operating
Damage caused by misuse is not covered by the warranty

Introduction

Thank you for choosing the Adastra RM-series rackmount 100V amplifier as part of your public address system. This amplifier is designed to offer high quality, dependable service for mobile and installed systems. Please read this manual fully and follow the instructions to achieve the best results with your new purchase and to avoid damage through misuse.

SAFETY SYMBOL AND MESSAGE CONVENTIONS



CAUTION
RISK OF ELECTRIC SHOCK
DO NOT OPEN

AVIS
RISQUE DE CHOC ELECTRIQUE NE PAS
OUVRIR



This symbol indicates that dangerous voltage constituting a risk of electric shock is present within this unit



This symbol indicates that there are important operating and maintenance instructions in the literature accompanying this unit.



SAFETY NOTICE

1. Prior to use, read through this manual
2. Keep the manual in good condition
3. Pay attention to safety warnings
4. Observe all operating requirements
5. Do not use the device near water or wet areas
6. For cleaning, only use a lint-free, dry cloth
7. Install according to the specifications
8. Place away from heat sources or heating appliances
9. Use mains lead provided and avoid damage to cable or connectors
10. Unplug power from mains during stormy weather or if unused for long periods
11. In case of malfunction, water ingress or other damage, consult qualified service personnel
12. Do not place in damp areas or near liquids or moisture. Do not spill liquids on the housing
13. Please pay attention to warning symbols during transit and placement
14. Terminals marked with the $\frac{1}{2}$ symbol are HAZARDOUS LIVE and should only be connected by qualified personnel
15. Ensure that the apparatus is connected to a mains socket with a protective EARTH connection
16. Ensure correct operation of the mains switch

Warning

To prevent the risk of fire or electric shock, do not expose any components to rain or moisture.

If liquids are spilled on the casing, stop using immediately, allow unit to dry out and have checked by qualified personnel before further use. Avoid impact, extreme pressure or heavy vibration to the case

No user serviceable parts inside – Do not open the case – refer all servicing to qualified service personnel.

Safety

- Check for correct mains voltage and condition of IEC lead before connecting to power outlet
- Use double insulated speaker wire with adequate current rating for 100V speaker connections
- Only use one type of output – i.e. 8Ω or 100V – do not mix or combine these outputs on a single zone or output
- Do not connect 8Ω speakers to the 100V terminal or 100V speakers to the 8Ω terminal
- Do not allow any foreign objects to enter the case or through the ventilation grilles

Placement

- Keep out of direct sunlight and away from heat sources
- Keep away from damp or dusty environments
- For rack-mounting, use the rack ears provided and ensure adequate support for the weight of the amplifier
- Ensure adequate air-flow and do not cover cooling vents at the front and rear of the amplifier
- Ensure adequate access to controls and connections

Cleaning

- Use a soft cloth with a neutral detergent to clean the casing as required
- Use a vacuum cleaner to clear ventilation grilles of any dust or debris build-ups
- Do not use strong solvents for cleaning the unit

Front panel

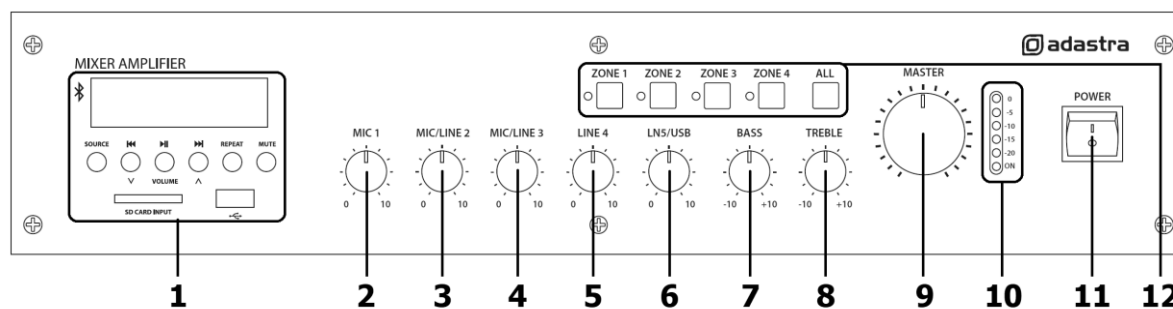

- | | |
|------------------------------|--|
| 1. USB/SD/FM/BT media player | 7. BASS EQ control |
| 2. MIC 1 volume control | 8. TREBLE EQ control |
| 3. MIC/LINE 2 volume control | 9. MASTER volume control |
| 4. MIC/LINE 3 volume control | 10. VU level meter |
| 5. LINE 4 volume control | 11. POWER on/off switch |
| 6. LNS/USB volume control | 12. Speaker zone selector buttons (RM240S/RM360S only) |

Rear panel

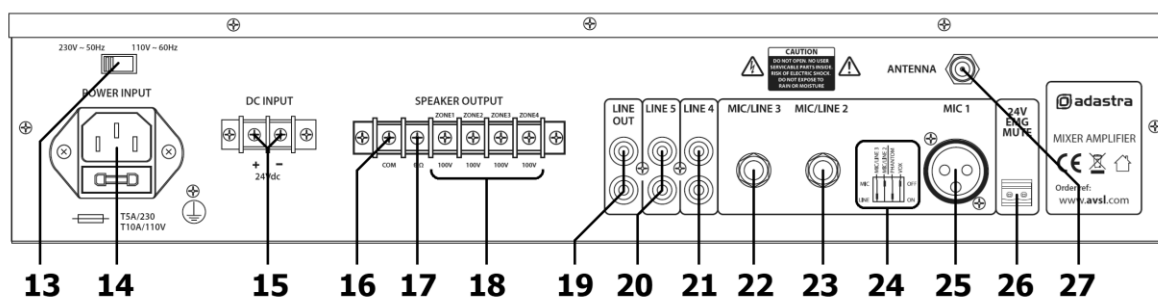

- | | |
|--|---|
| 13. Mains voltage switch | 21. LINE 4 input (RCA) |
| 14. IEC mains inlet & fuse holder | 22. MIC/LINE 3 input (6.3mm jack) |
| 15. DC power terminals | 23. MIC/LINE 2 input (6.3mm jack) |
| 16. COM speaker terminal | 24. DIP switches (see DIP switches section below) |
| 17. 8Ω speaker terminal | 25. MIC 1 input (balanced XLR) |
| 18. 100V speaker terminals (1 zone for RM60 / RM120) | 26. 24V Mute contacts |
| 19. LINE OUT connectors (RCA) | 27. Antenna connection for FM tuner |
| 20. LINE 5 input (RCA) | |

DIP switches (24)

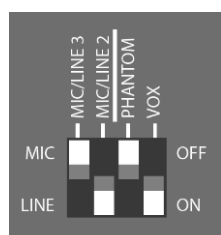

MIC 1 channel has an option for +20V phantom power for condenser microphones and paging microphones with chimes.

MIC 1 also has the option of VOX control, which attenuates the line input channels 4 and 5 by -40dB when MIC 1 signal is detected and returns them to normal when MIC 1 signal is silent.

MIC/LINE 2 (23) and MIC/LINE 3 (22) inputs can be set to MIC (up position) or LINE (down position) sensitivity to suit the type of input being used. Be sure to make these DIP switch settings when the amplifier is switched off. Making any changes when the amplifier is powered up may cause loud noises which can damage the speakers.

Connection and setup

Connect the rear IEC inlet (14) to the mains using the supplied mains lead (or an equivalent approved type). Ensure that the correct voltage is indicated on the voltage selector (13) and the mains outlet is switched on.

Alternatively, the amplifier can be powered by a 24V battery, such as a lorry or boat battery, by connecting the "+" and "-" of the battery to the DC INPUT (15) on the rear panel. Ensure that DC cables are capable of handling the required current (10A min. recommended)

The RM series amplifiers have a total of 5 input channels. MIC 1 input (25) is fed to a dedicated microphone channel. Connect the main announcement microphone to this channel using a balanced XLR lead.

Connect microphones or mono line inputs to MIC/LINE 2 and MIC/LINE 3 inputs (23, 22) using good quality 6.3mm jack leads. Make sure the correct sensitivity is selected for the type of input source.

Connect any other line level audio inputs to the LINE 4 (21) and LINE 5 (20) connectors on the rear panel using good quality RCA leads. Since RM series amplifiers have a mono output, stereo signals will be summed together.

Further mixer-amplifiers or slave amplifiers can be connected from the rear LINE OUT sockets (19), again using a good quality RCA lead. This output carries the full mix of all channels 1-5 as fed to the speakers.

Speaker outputs

The RM series amplifiers can be used either as 100V line amplifiers or standard low impedance power amplifiers. These 2 configurations cannot be used together, so it is important to decide which method will be used at the start.

100V line systems

For 100V line systems, connect the amplifier to the first speaker in the system using double-insulated speaker wire which has adequate current rating to handle the total output of the amplifier.

Connect the "100V" (18) output terminal to the positive (+) connection of the speaker and "COM" output (16) to the negative (-) connection of the speaker. Connect further speakers in parallel to the first speaker with all positive terminals and connected together and all negative terminals connected together as shown below.

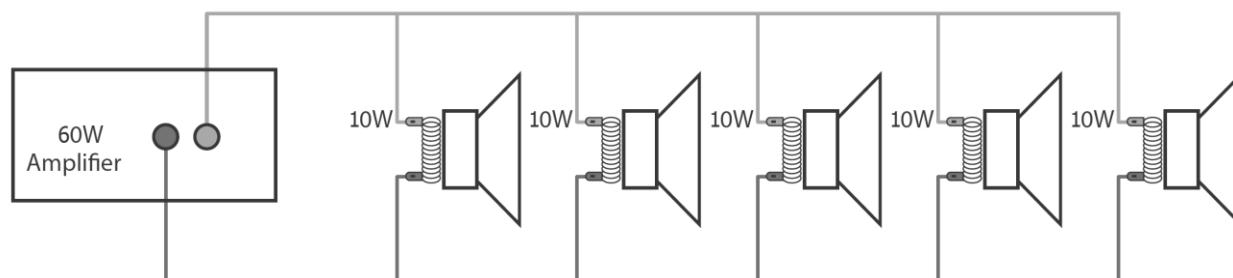

A 100V line speaker system can comprise of many speakers connected together. The determining factor for how many speakers can be used on a single amplifier is the power rating. For most purposes, it is advised to connect as many speakers as needed with a combined wattage of no more than 90% of the amplifier's output power rating.

The terminals of a 100V speaker are connected to a transformer and in some cases, this transformer may be "tapped" for different power ratings. These tapings can be used to adjust the wattage (and output volume) of each speaker in the system to help achieve the ideal total power of the system for the amplifier.

Speaker switching zones (RM240S and RM360S)

The RM240S and RM360S have 4 separate terminals for 100V speakers. Any 100V speakers connected to the terminals labelled 100V or ZONE 1 / ZONE 2 / ZONE 3 / ZONE 4 (+) and COM (-) will be governed by 4 front panel speaker switches (12)

(e.g. a speaker connected to ZONE 1 + COM will be enabled if Zone 1 button is depressed on the front panel)

There is also a switch labelled "ALL" on the front panel which enables output to all zones 1 to 4.

Low impedance systems

Alternatively, RM series amplifiers can be used to drive a low impedance speaker by connecting the "8Ω" terminal (17) to the positive (+) speaker connection and "COM" terminal (16) to the negative (-) speaker connection.

Do not use 8Ω and 100V at the same time.

Emergency mute function

RM series mixer-amplifiers are equipped with a Euroblock connector for a 24V mute function (26). These contacts can be wired to an emergency panel (such as a fire alarm) which has a 24V trigger output. (The 24V contacts can be connected with either polarity +/- or -/+ to operate) When the alarm is activated, the RM mixer-amplifier will mute all channels except for MIC1, which remains active for emergency announcements.

Operation

When all connections to the amplifier are made, turn all rotary controls down and switch on the power (11) and a power "ON" LED will illuminate.

Turn BASS and TREBLE controls (7, 8) to the 12 o'clock position (pointing straight up) and turn the MASTER rotary control (9) up part way for testing.

Ensure a signal is being fed to one of the line inputs 2, 3, 4 or 5 and gradually increase the volume control for that channel until the output is heard through the speakers.

Turn up the MASTER to the maximum required volume level and reduce the channel volume control if necessary.

Repeat this process for any other line inputs connected to channels 2, 3, 4 or 5.

Note: If a line input is not connected to an RM series mixer-amplifier, the initial test can be made using the built-in media player. See the "Media player" section for instructions.

Both the media player output and LINE 5 input are governed by the LN5/USB volume control.

The output of the amplifier is represented on the VU meter LEDs (10) and care should be taken that the red "0" LED is only lit momentarily during use. Anything longer than a short flash of this LED may be indicating distortion or clipping of the output signal and the MASTER volume control or channel volume control should be turned down.

If a microphone is connected to MIC 1 input, make sure it is switched on and if it requires phantom power, make sure this feature is enabled on the DIP switch. Gradually increase the MIC 1 control (2) whilst speaking into the microphone until the required volume level is reached.

The microphone should not be able to “hear” the speakers, which can cause feedback (squealing or howling) Repeat this process for microphones or line inputs connected via the MIC/LINE 2 and 3 inputs.

If the VOX feature is enabled, audio playback through channels 4 and 5 will be reduced in volume automatically when speaking into MIC 1.

In addition to channel and MASTER volume controls, there are BASS and TREBLE EQ controls (7, 8) to adjust the tone of the overall output. At the 12 o’clock position, these controls apply no effect to the signal (no boost or cut).

Moving the BASS control clockwise boosts the low frequencies in the audio, whilst moving it anticlockwise will cut these low frequencies. Likewise, moving the TREBLE control clockwise boosts the high frequencies in the audio, whilst moving it anticlockwise will cut these high frequencies.

Adjust these EQ controls to suit the type of audio signal or compensate for the room acoustics.

Media player

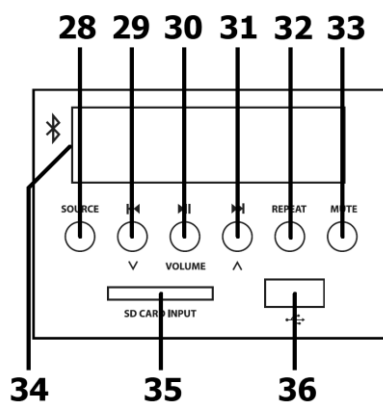

- 28. SOURCE select button
- 29. Previous / volume down button
- 30. Play / pause button
- 31. Next / volume up button
- 32. REPEAT mode button
- 33. MUTE button
- 34. Media player display
- 35. SD card slot
- 36. USB input

RM60, RM120, RM240S and RM360S mixer-amplifiers are fitted with a built-in media player. This section comprises a Bluetooth receiver, USB/SD audio player and FM tuner.

Pressing the SOURCE select button (1) will step through Bluetooth, USB, SD card and FM tuner modes.

Bluetooth

The Bluetooth function allows connection of a smart phone or tablet to the media player section for playback of stored files or streamed digital audio.

In order to enable this function, it will be necessary to pair the sending device to the receiver as follows.

1. Open the Bluetooth settings menu on the smart phone or tablet (or other sending device)
2. Scan for Bluetooth devices and look for “adastra 0000” in the list of available devices (ensure that the RM amp is powered on and within reception range)
3. Select “adastra 0000” and the sending device should confirm that it is connected as an audio device. (note that “0000” may be a different number if it has been edited – see below)
4. Play audio from the sending device, ensuring that volume controls are not turned down/muted
5. Turn up the LN5/USB volume control on the amplifier to the required level.

The Previous, Next and Play/pause buttons will operate in Bluetooth as remote playback controls. Holding the Previous track or Next track buttons (2, 5) will adjust the output volume of the player.

The Bluetooth name can be customized to enable identification of individual nearby amplifiers.

To customize the Bluetooth number press and hold the Play/Pause button until adastra 0000 is displayed with one of the characters flashing.

Press Previous or Next buttons to edit the number and Play/Pause to select another character. Hold Play/Pause to store the ID and exit.

Note: Android devices have the facility to re-name devices within the Bluetooth settings menu. If a the Bluetooth ID has been re-named on the Android device, editing the Bluetooth ID on the media player will not affect the name displayed on that Android device.

FM Tuner

The FM tuner function operates in the same way as a standard FM radio and benefits from the connection of an FM antenna to the rear panel 'F' type connector.

If no channels are tuned in, press the Play/Pause button (4) to begin auto tuning, which scans available stations and stores them as channels within the FM tuner. Pressing Play/Pause again will abort the auto-tuning.

To step through pre-set stations, press the Previous or Next buttons. Holding the Previous track or Next track buttons will adjust the output volume of the player.

USB/SD player

When a USB memory stick is inserted into the USB port (9) or SD card into the SD slot (3), the USB or SD symbol will show in the display and any compressed audio files will start to play automatically. The last connected media will take priority.

If playback does not start automatically, press the SOURCE select button (1) and Play/Pause button (4) to check if the player is set to the correct mode. Try Previous track and Next track buttons (2, 5) if the selected track is unable to play. Check that the audio files are mp3 type.

Turn up USB/LN5 volume control to hear the output from the speakers and increase to the required level.

There are 3 Repeat modes: RTA (Repeat all tracks), RT1 (Repeat current track) and RND (Random). Pressing the "REPEAT" button (32) will cycle through these modes as shown in the top right of the display.

Pressing the Previous track button (2) briefly steps backwards through tracks on the memory device. Press and hold this button to decrease the playback volume.

Pressing the Next track button (5) briefly steps forwards through tracks on the memory device. Press and hold this button to increase the playback volume.

To pause the current track, press the Play/Pause button (4) and press it again to resume playback. The display shows the track number when a track is selected and then elapsed time during playback

To avoid loud pops through the speakers, turn down the MASTER control before powering down.

Specifications

Model	RM60	RM120	RM240S	RM360S
Power supply	110/230Vac, 50/60Hz (IEC) or 24Vdc option (screw terminals)			
Output power: RMS	60Wrms	120Wrms	240Wrms	360Wrms

Outputs: Speaker	100V / 8Ω / COM	4x100V / 8Ω / COM
Output: Line	RCA signal output	
Inputs	Mic XLR, 2 x mic/line jack, 2 x RCA line, 24V mute contacts, RF antenna	
Volume controls	Mic1, mic/line2+3, line4+5 (USB), master	
Equalizer: Bass / Treble	100Hz ±10dB / 10kHz ±10dB	
Bluetooth version	2.0	
Phantom power	+20V (MIC 1 input)	
THD	<1.0%	
Dimensions	433 x 320 x 89mm	433x410x89mm
Weight	5.98kg	8.36kg
		9.62kg
		12.68kg

Troubleshooting

No power LED on control panel	Ensure IEC lead is in good condition and connected properly
	Ensure POWER switch is on and check mains inlet fuse
Power LED is on but no other LEDs and no output	Check input signals and condition of input connection leads
	Check MASTER, MIC, LINE or USB/SD volume controls are turned up
Power light and output LEDs lighting but no output	Check speaker output terminals are connected correctly
	Check speakers are working (test on another amp if available)
	Check memory device is connected properly (remove and re-insert)
	Check file types – standard mp3 digital audio files required
Bluetooth cannot connect	Check memory device works on a PC or Mac for standard playback
	Ensure that Bluetooth is enabled on sending device
	Ensure that the sending device is within Bluetooth range (5-10m)
	Check that "adastra *****" is the connected device
No audio from Bluetooth device	If there are more than one "adastra *****" devices, check each in turn
	Ensure that volume controls are not turned down on sending device
	If one of many "adastra *****" devices, edit the Bluetooth ID
Output too loud or distorted	Check volume and Play/Pause buttons in case Bluetooth is muted
	Reduce MIC, LINE IN, USB/SD and/or MASTER level
Output too quiet or inaudible	Ensure Hi-Z line level input(s) not connected via MIC input
	Increase MIC, LINE IN, USB/SD and/or MASTER level
	Check for quiet recording of media files on USB
No microphone output	Check VOX override is not unintentionally suppressing audio playback
Feedback from microphone	Check phantom power is enabled if using a condenser microphone
Amplifier overheating	Face microphone away from speakers and monitors and reduce level
	Ensure cooling vents are clear from debris and dust
	Check that 4, 8 or 16Ω speakers are not connected to 100V terminals
	Ensure total 100V speaker wattage is lower than amplifier rating
	Ensure that 100V and 4, 8 or 16Ω speakers are not both connected
	Ensure that total load connected to 4 - 16Ω output is not less than 4Ω



Disposal: The "Crossed Wheelie Bin" symbol on the product means that the product is classed as Electrical or Electronic equipment and should not be disposed with other household or commercial waste at the end of its useful life. The goods must be disposed of according to your local council guidelines.

Hereby, AVSL Group Ltd. declares that the radio equipment type 953.213UK, 953.214UK, 953.215UK and 953.216UK are in compliance with [Directive 2014/53/EU](#)

The full text of the EU declaration of conformity for 953.213UK is available at the following internet address:
<http://www.avsl.com/assets/exportdoc/9/5/953213UK%20CE.pdf>

The full text of the EU declaration of conformity for 953.214UK is available at the following internet address:
<http://www.avsl.com/assets/exportdoc/9/5/953214UK%20CE.pdf>

The full text of the EU declaration of conformity for 953.215UK is available at the following internet address:
<http://www.avsl.com/assets/exportdoc/9/5/953215UK%20CE.pdf>

The full text of the EU declaration of conformity for 953.216UK is available at the following internet address:
<http://www.avsl.com/assets/exportdoc/9/5/953216UK%20CE.pdf>

Errors and omissions excepted. Copyright© 2021.

AVSL Group Ltd. Unit 2-4 Bridgewater Park, Taylor Rd. Manchester. M41 7JQ

AVSL (EUROPE) Ltd, Unit 3D North Point House, North Point Business Park, New Mallow Road, Cork, Ireland.