

Intelligent Mains Switching Input/Output Unit Installation Guide

Part No	Product Name
SA4700-103APO	Intelligent Mains Switching Input/Output Unit

Technical Information

All data is supplied subject to change without notice. Specifications are typical at 24V, 25°C and 50% RH unless otherwise stated.

Supply Voltage	17-35V dc
Quiescent Current	700µA
Power-up Surge Current	1.1mA
Relay Output Contact Rating	5A at 30V dc or 250V ac
LED Current	1.6mA per LED
Maximum Loop Current	1A
(I_{e,max}; L1 in/out)	
Operating Temperature	-40°C to 70°C
Humidity	0% to 95% RH (no condensation or icing)
Approvals	EN 54-17 & EN 54-18

For additional technical information please refer to the following documents which are available on request.

PP2556 - Intelligent Mains Switching Input/Output Unit



DANGER! ELECTRIC SHOCK!

This label indicates the risk of hazardous voltage and electric shock which will cause death, serious injury, or substantial damage. Turn off power supplying this device before working inside.

1

i Drill holes where required.

2

! Do not over tighten screws

3

i Remove knockouts and fit glands where required.

4

5

! Do not over tighten screws

6

i See Table 1

126

! The 8th segment must be in set to '0' for Discovery / XP95 operation

7

! All CI tests must be carried before connecting the interface. For connectivity instruction see Figs 1, 2 & 3

8

i Note the alignment marks

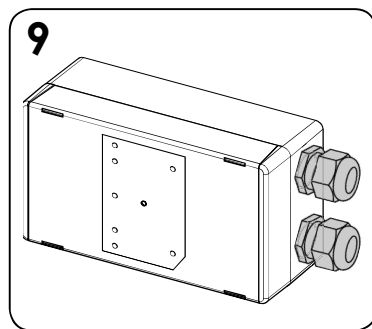

Addressing

Table 1

	XP95 / Discovery Systems	CoreProtocol Systems
Segment	1	Sets the address
	2	
	3	
	4	
	5	
	6	
	7	
	8	Set to '0' (Fault value is returned if set to '1')
FS	Enables failsafe mode (compliant with BS7273-4 for door holders)	Enables failsafe mode (compliant with BS7273-4 for door holders)
LED	Enables/Disables LED (except Isolator LED)	Enables/Disables LED (except Isolator LED)

Note: On mixed systems addresses 127 and 128 are reserved. Refer to system's panel manufacturer for further information.

Address Setting Examples

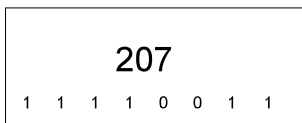
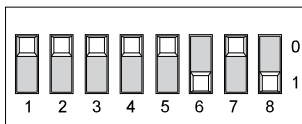
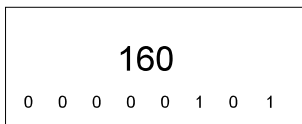
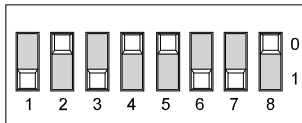
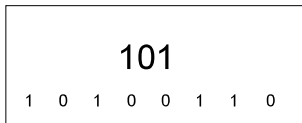
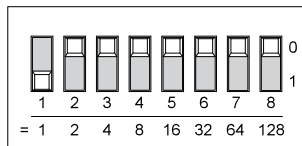

Connectivity Examples

Fig. 1 Standard resistive monitoring mode

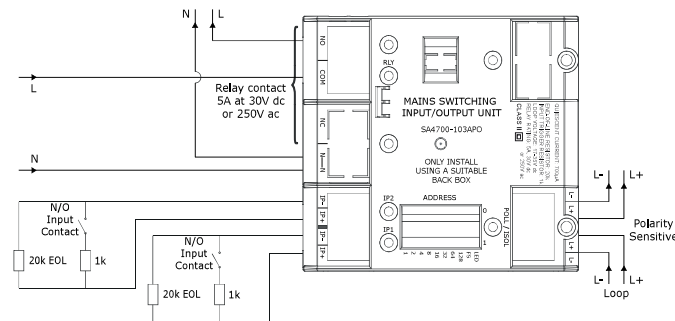

When operated under XP95 or Discovery Protocols, EN54-13 type 2 devices can be connected. In case EN54-13 type 1 devices need to be connected they must be installed directly next to this module, with no transmission path according to EN 54-13.

Fig. 2 Normally open and normally closed contact monitoring mode (compatible with CoreProtocol only)

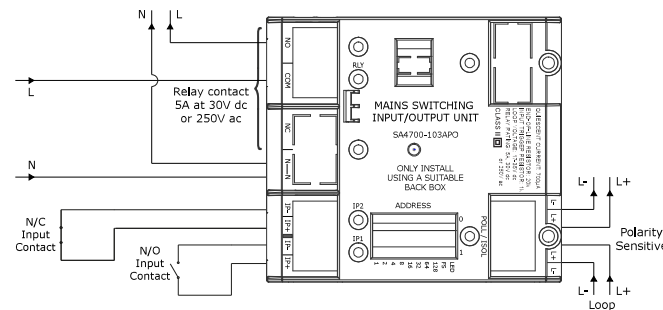

Caution

The Mains Switching Input/Output Unit is not designed for outdoor use unless it is mounted in a suitable weatherproof enclosure. It is designed to switch voltages of up to 250V and should be installed with all due care by a qualified person. Isolate mains supply before starting work. This equipment is not suitable for use in locations where children are likely to be present.

LED Status Indicator

RLY	Continuous Red	Relay Active
	Continuous Yellow	Fault
POLL/ISO	Flashing Green	Device Polled
	Continuous Yellow	Isolator Active
IP	Continuous Red	Input Active
	Continuous Yellow	Input Fault

Note:

Not all LEDs can be on simultaneously.

Commissioning

The installation must conform to BS5839-1 (or applicable local codes). This product is to be installed in an area accessible only to skilled persons and instructed persons with the proper authorisation.

Maintenance

Removal of the external cover must be carried out using a flat screwdriver or similar tool.

Troubleshooting

Before investigating individual units for faults, it is important to check that the system wiring is fault free. Earth faults on data loops or interface zone wiring may cause communication errors. Many fault conditions are the result of simple wiring errors. Check all connections to the unit.

Problem Possible Cause

No response or missing	Incorrect address setting
Fault condition reported	Incorrect loop wiring
Relay fails to operate	Incorrect input wiring
	Incorrect end-of-line resistor fitted
	Incorrect wiring
	Control panel has incorrect cause and effect programming
Analogue value unstable	Dual address
	Loop data fault, data corruption
Constant Alarm	Incorrect wiring
	Incorrect end-of-line resistor fitted
	Incompatible control panel software
Isolator LED on	Short-circuit on loop wiring
	Wiring reverse polarity
	Too many devices between isolators

Mode Table*

Mode	Description
1	DIL Switch XP Mode
2	Alarm Delays
3	Output and N/O input (can be equivalent for Output only)
4	Output and N/C input
5	Output with Feedback (1st input N/C, 2nd input N/O)
6	Failsafe Output with Feedback (1st input N/C, 2nd input N/O)
7	Failsafe Output without Feedback
8	Momentary Input Activation Sets Output Relay
9	Input Activation Sets Output

*CoreProtocol enabled systems only