

Networking

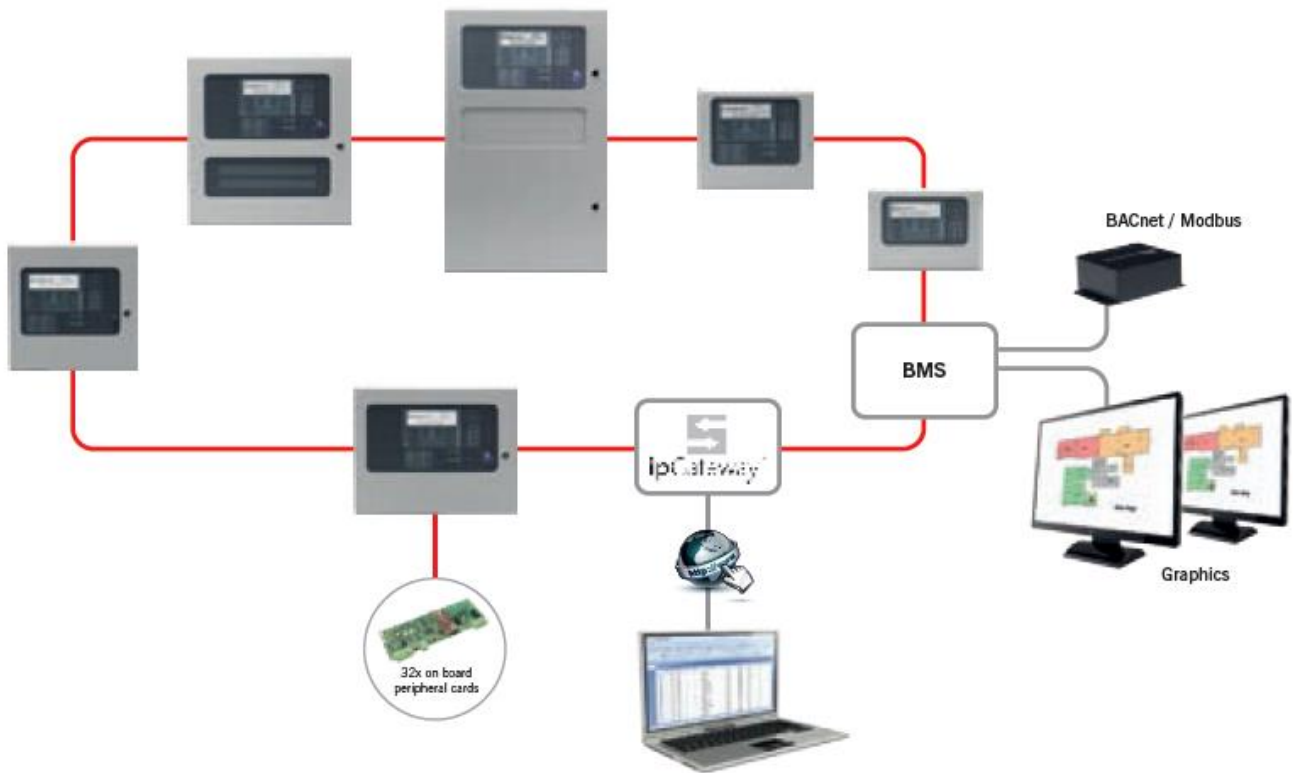

This application note describes how install and configure Mx-5000 Networks.



Models, Sales Order Parts:

- Mxp-503:** Standard Network Card
- Mxp-509:** Fault Tolerant Network Card

Applications / Limitations:

Standard Network: The maximum total cable length is 1.5km. The maximum number of network nodes is 32 (50 with signal buffer)

Fault Tolerant Network: The maximum cable length is 1.5km between each node and the maximum total loop length is 20km. Each network card has in-built diagnostics and is fully monitored for both short and open circuit faults between nodes. The network is capable of withstanding a single fault between nodes without loss of communications to any single panel. The maximum number of network nodes is 200.

Compatibility:

The Network cards are compatible with all Mx-5000 series control panels.

The Remote Terminals Mx-5010/Mx-5020/Mx-5030, BMS/Graphics interface and other network peripherals such as Advanced Mimic Units (AMU) all have integral network cards built-in. (Only use fault tolerant Peripherals and Remote Terminals on a fault tolerant network).

Software Version 050-00 onwards

Mx-4000 Series: The network may include panels and network peripherals from the Mx-4000 series. However, please note that this will restrict the number of zones and sectors that can be used. Other enhanced features of the Mx-5000 network are also not available on the Mx-4000 Series panels.

Item	Specification Details						
Network connections	<table style="width: 100%; border: none;"> <tr> <td style="width: 50%;">IN: A</td> <td style="width: 50%;">OUT: A</td> </tr> <tr> <td>B</td> <td>B</td> </tr> <tr> <td>SCN (Screen)</td> <td>SCN (Screen)</td> </tr> </table>	IN: A	OUT: A	B	B	SCN (Screen)	SCN (Screen)
IN: A	OUT: A						
B	B						
SCN (Screen)	SCN (Screen)						
On-board Indication	2 LEDs. LED 1 illuminates when data is transmitted. LED 2 illuminates when data is received.						
Supply current	Mxp-503 Standard Network Card: 20mA Mxp-509 Fault Tolerant Network Card: 43mA (All power taken directly from the panel motherboard)						
Temperature range and Humidity	-5°C to 40°C 95% non-condensing (maximum)						
Dimensions (H x W x D)	85mm x 65mm x 20mm (Mounting pillars are provided on the panel base cards to mount this card).						
Recommended Cable	Two-core twisted-pair plus screen. (A list of recommended fire rated and non-fire rated cables, including manufacturer and cable type, is included at the end of this data sheet).						

As our policy is one of constant product improvement the right is therefore reserved to modify product specifications without prior notice

Table of Contents

1	INTRODUCTION.....	4
1.1	Key Features	4
1.2	Specifications	5
2	INSTALLATION.....	6
2.1	Installing the Panel Network Card	6
2.2	Wiring Installation	6
2.3	Fault Tolerant Fibre Networks	8
3	CONFIGURATION AND PROGRAMMING.....	9
3.1	Initial Configuration.....	9
3.1.1	<i>Configuring a Network from the PC.....</i>	<i>9</i>
3.1.2	<i>Configuring a Network at the Panel.....</i>	<i>10</i>
3.2	Adding a Node to the Network	10
3.3	Making Changes to a Panel	11
3.4	Changing Time and Date	11
4	DIAGNOSTICS TOOLS.....	12
4.1	Fault Tolerant Network Card Software version	12
4.2	Printed Circuit Card Indicators	12
4.3	Panel Network Analyser	13
4.3.1	<i>Network Diagnostics – Duplicated Nodes.....</i>	<i>13</i>
4.3.2	<i>Network Diagnostics – Duplicated Zones.....</i>	<i>14</i>
4.3.3	<i>Network Diagnostics – Additional Fault Tolerant Information.....</i>	<i>14</i>
4.3.4	<i>Network Diagnostics – Fibre Networks.....</i>	<i>14</i>
4.3.5	<i>Network Diagnostics – Statistical Analysis</i>	<i>15</i>
5	COMMON FAULTS / PROBLEMS.....	16
5.1	Corruption in the Transmission of Data.....	16
6	RECOMMENDED CABLES	17
6.1	Fire rated cable.....	17
6.2	Non-Fire rated cables	17

1 Introduction

The **Ad-NeT** network is a true peer-to-peer token passing system that has been optimised for fire systems. It allows larger buildings to be protected by distributing the fire panels throughout the building, instead of having to take all the detection circuits back to a single point.

Details of all Fires, Alarms, Pre-alarms and Faults are passed over the network, allowing any panel or display terminal in the building to show information as required. Each fire panel can be programmed with appropriate cause-and-effect for the entire building.

The installation can also be partitioned into sectors (i.e. for multiple building sites such as college campuses) and each panel can be assigned to a specific sector. Control key and other operations can be defined, at each panel, to be effective and respond to commands issued in some, all or none of the other sectors.

Panels, Display Terminals, BMS / Graphics Interfaces and Advanced Mimic Units can be integrated within the network without the use of special installation spurs or other dedicated interfaces and wiring.

The fault tolerant (secure) network will continue to operate fully even if there is a single open or short circuit fault condition on any one of the installation cables. In addition, the network diagnostics view option gives detailed and clear information to identify the location of any network cable fault conditions.

1.1 Key Features

Advanced Fire Panel Technology

- The *Ad-NeT* network system allows all *Mx-5000* series control panels, remote terminals and network peripherals to be connected together using standard fire resistant two-core cable.
- It provides both the benefits of distributed intelligence and reduced installation costs whilst catering for the smallest two-panel network through to the largest 200 panel wide area networked system.
- The network operates as a true peer-to-peer system allowing information from any input or output device to be passed over the network and displayed on any *Mx-5000* control panel or remote terminal as required.
- Details include Fire, General Alarm, Pre-alarm, Fault, Control Inputs and Disablement as well as analogue values, test instructions and status information.
- The network is available in two formats:
 - Ad-NeT Network (Radial Format)
 - Ad-NeT+ Network (Secure Format)
- The *Ad-NeT* system *DynamiX* zoning facility allows the networked system to share up-to 2000 zones giving non-confusing indication and allowing true peer-to-peer cross panel report, control and site-wide cause and effect functionality.
- Simply adding and connecting a network card allows any *Mx-5000* control panel or remote terminal to be networked. All other nodes on the *Ad-NeT* system will be instantly aware of a panel as soon as it is given a valid network node address, allowing additional panels to be added at any time with a minimum amount of reprogramming. All panels incorporate a network analyser providing valuable diagnostic and status information and also have the facility to prevent the transmission of fires or faults during commissioning.
- For more complex systems, the Windows based *PC-NeT* Mx configuration software allows sector based programming for Mute, Silence, Resound and Reset control keys as well as investigation delays, group disablement and test instructions. All panels within the same sector will share common controls and each panel or remote terminal can also be programmed to show specific network information on a zone basis.
- For cause and effect, any input device can be programmed to operate any output device on any panel and, to simplify the programming, all the configuration data is contained within one user-friendly network configuration file.

1.2 Specifications

Item	Specification	
Number of Zones	2000	
Number Nodes	200	
Number of Sectors	100	<div style="border: 1px solid black; padding: 2px; display: inline-block;"> PC <small>ONLY</small> </div>



Where you see the “PC Only” symbol, these features can be either only set-up using the PC Configuration Tool or there are additional options that are only available via the PC Configuration Tool.

2 Installation



Isolate ALL sources of power before installing or removing printed circuit boards.



Observe anti-static precautions at all times when handling printed circuit boards.

2.1 Installing the Panel Network Card

An Mxp-503 (STD) or an Mxp-509 (FT) Network Card can be installed onto the base card.

The card is fitted to the base card using 2x M3 screw and 2x plastic pillars. Metal pillars are pre-fitted to the base card. Refer to the diagram opposite.

All signals and power required for operation of the card are provided on the plug-in connections.

Plug the ribbon cable into the connector as shown.

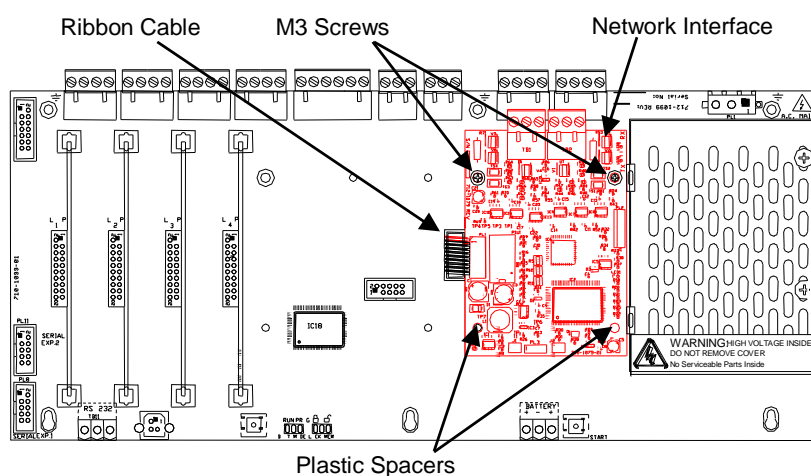

The screw fixing is essential for EMC Immunity protection.

Mounting Position for the Network Card (Example Mx-5400)



Isolate ALL sources of power before installing or removing printed circuit boards.



Observe anti-static precautions at all times when handling printed circuit boards.

2.2 Wiring Installation

All electrical wiring installation work should be carried out in accordance with the code of practice or applicable national standards appropriate to the country of installation.

To maintain electrical integrity of the SELV wiring on the input, output, loop and communications lines all SELV wiring should be segregated from the LV mains wiring and be wired using cable with insulation suitable for the application.

To minimise the effects of EMC interference all data wiring circuits should be wired with a twisted pair of conductors with a cross sectional area suitable for the loading conditions.

In areas where cabling may come into contact with high frequency interference, such as portable radio transceivers etc. the data wiring cable should be of a twisted pair construction within an overall screen. Care should be taken to correctly terminate this screen, refer to the information below.

NB: Minimum / Maximum cable size for all external connections is limited to 0.5mm² / 2.5mm² (22-14AWG).

The network permits the connection of other panels, remote terminals and other devices to complete a distributed system.

Either an Mxp-503 (STD) standard network interface card or an Mxp-509 (FT) fault tolerant network interface card must be installed in the panel. All network nodes must be installed with the same type of interface.

Cable must be twisted pair 18AWG or 20AWG.

Screened type cable is recommended (e.g. Belden 8760, 8762). Connect the screen to the designated terminal block positions only.

Each interface card has independent connectors for the outgoing and incoming network cable. Using a twisted-pair cable, connect from the "OUT" socket on the first panel to the "IN" socket on the next panel as follows.

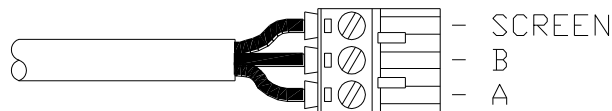
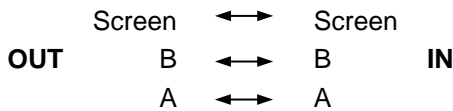
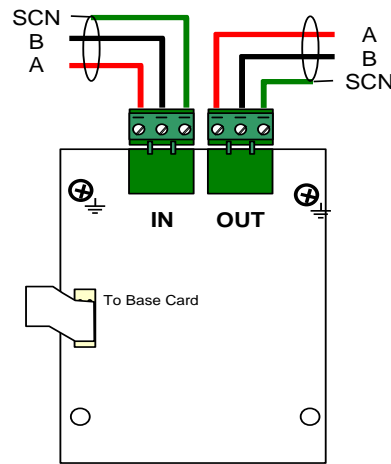

STD (Up to 32 nodes)

The "IN" terminals on the first node and the "OUT" terminals on the last node are not used. Connect an ELR (150Ω) resistor between A and B on the terminal blocks of the unused sockets.

Maximum cable length (overall length) is 1500m using recommended cables.

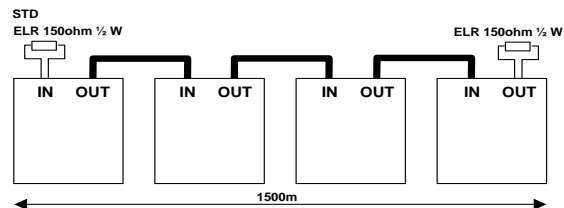

FT (Up to 200 nodes)

ALL Network devices must be fitted with a FT type adaptor card.

Install a cable from the last node "OUT" terminals back to the first node "IN" terminals to form a ring.

Maximum cable length between nodes is 1500m using recommended cables. Maximum cable length (overall length) is 20000m using recommended cables.

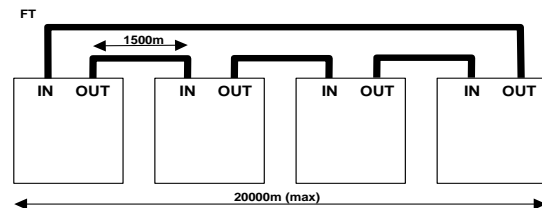

For future easy reference, label the cables with their respective use, i.e. NET IN or NET OUT. Use the cable tie markers and labels supplied. It may also be useful to indicate the node numbers from / to which the panel is physically connected.



DO NOT connect the panels using spur wiring.



Special screen termination circuits are included on the circuit card to prevent mains frequency earth-loop currents flowing between network nodes. Always connect the cable screen to the screen termination on the network connector. DO NOT connect the cable screen to any other point.

Always connect the separate lengths of cable to their respective IN and OUT connectors otherwise the special cable screen termination arrangement will not work and the installation may be susceptible to unwanted noise interference.



Where practical, the order of the node numbers should follow the sequence 1, 2, 3, etc. in line with the physical cabling – this will greatly assist should it be necessary to diagnose any network problems.



Until the installation of a FT ring is completed, the panels will indicate a ring fault condition. In this condition, the network will operate fully but will not be tolerant to a second fault condition. Upon successful completion of the ring, the fault condition will be automatically cancelled.

2.3 Fault Tolerant Fibre Networks

It is possible to make connections on a fault tolerant networked system using fibre optic cable.

Fibre optic cable is completely immune to external electrical interference, which makes it ideal for harsh environments.

A suitable pair of RS485 to fibre optic interfaces is required for each fibre section. The fibre interfaces provide two fibre links between each interface so that communications can be made in either direction.

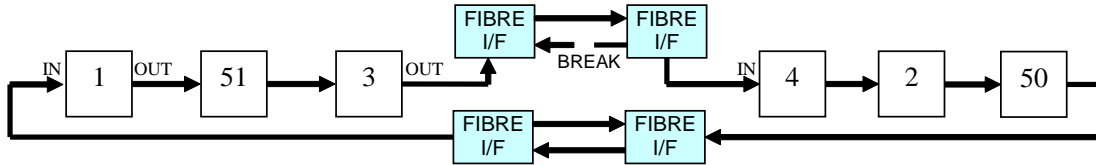

EXAMPLE: A system that includes fibre-optic links between nodes 3 and 4 and between nodes 50 and 1. A break in a fibre optic cable is shown between the transmit output of the fibre interface connected to node 4 and the receive input of the fibre interface connected to node 3 – refer to diagnostics section on how this fault is reported.

Contact Advanced Sales / Technical Support for further information on available options.

3 Configuration and Programming

3.1 Initial Configuration

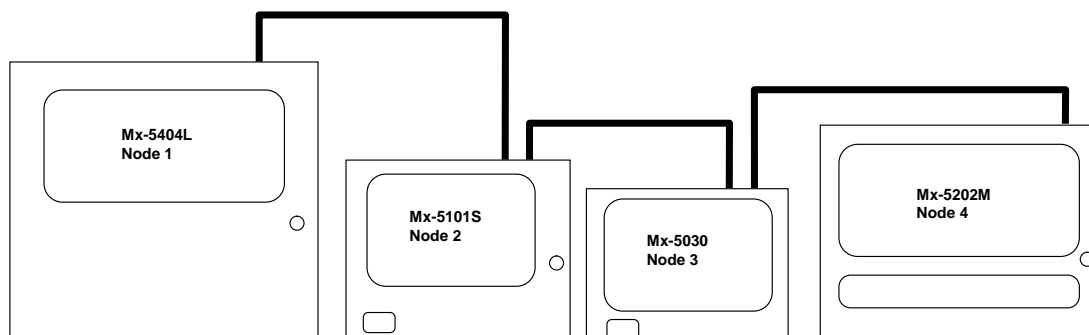

A network can be configured either directly from the panel, or from a PC. The PC can give greater flexibility over displays, but the fundamental network principles remain the same.

Each panel and display terminal connected to the network is termed a network “node”. In order to run on the network each node must be configured with the following information: -

- It must be given a unique node address.
- It must be told the address of the next node on the network.

Where practical, the order of the node numbers should follow the sequence 1, 2, 3, etc. in line with the physical cabling (Refer to the Section 2.2 for details on the installation wiring).

For instance, the above example would be programmed as follows:

Panel	This Node	Next Node
Mx-5404	1	2
Mx-5101	2	3
Mx-5030	3	4
Mx-5202	4	1

The first node on a network should always be node address 1 and be a fire panel (Remote Terminals can not be used as the first node). The last node on the network should have its “NEXT NETWORK NODE” address set to the address of the first node.

Simple networks can be set up directly from the panel.

3.1.1 Configuring a Network from the PC

PC
ONLY

The following features and functions can only be configured using the PC Configuration Tool.

- The Sector in which the panel is located.
- The selective display of the Zones from which fire alarms, pre-alarms, plant alarms, test alarms and faults, etc. will be displayed on each individual panel.
- The Sectors from which Silence, Resound, Mute and Reset commands will be accepted.
- The Sectors from which Stage 1/2 investigations, group disablements or test zones instructions will be accepted.
- Individual Device cause and effects on a panel and across the network.

Refer to the PC Configuration Tool Manual and on-line help for further information on the features and functions available.

3.1.2 Configuring a Network at the Panel

Select the "SETUP" option from "[Commission Menu 2]".

```
[Setup]
```

```
THIS NETWORK NODE : 0
NEXT NETWORK NODE : 0
PANEL ZONE        : 1997
SERVICE NUMBER   : 01234 56789
```

Enter the address of "THIS NETWORK NODE". Always ensure this is unique for each node on the network (entering Node "0" removes the panel from the network).

For example, if this is the first panel on the network, set it to "1".

The "NEXT NETWORK NODE" will then automatically change to "2". If panel 2 has not yet been fitted, then change the "NEXT NETWORK NODE" to the number of the next panel or display terminal that is actually connected to the network.



Note that the rest of the network will be aware of a panel as soon as it is given a valid network node address, but the network will not react to fires/faults etc from a panel that is still in the commissioning state (This is to reduce the risk of false alarms during commissioning).



You may notice the "Panel Zone" number change when a new node number is entered. This is only a suggestion. You can change it to any appropriate zone. However, please note that the zone assignment for ALL on-board circuits will be automatically re-assigned to this new zone number even if they had been previously changed.



Take care to ensure that the cause and effects dependent on specific panel zones and inputs from the 8-way input card remain correct after changing the panel zone. It is often easier to use the PC configuration tool to program the required zone assignment, input actions, etc. and then update this information in the panel.

It is recommended that the zone text corresponding to the panel zone should describe the physical location of the panel in the building (Panel zones and text can also be defined for each "On-board" circuit from the PC configuration program).

Providing all the detectors have been learnt and appropriate text entered, the panel is then ready to run on the network.

3.2 Adding a Node to the Network

It is quite common to add additional panels or detectors to a network, or make changes to the existing network (e.g. change a detector type, modify location text etc).

The network is designed to accommodate these types of changes with the minimum of reprogramming as follows: -

For example, suppose the existing network has three fire panels at nodes 1, 2 and 3. A new fire panel is now to be added.

Examples

Add the necessary wiring to connect the new node to the network

The preferred method is to add the node to the end of the line.

However, it is also possible to add the new node physically located between existing nodes to aid in cable routing – remember to break into the cable run – do not spur off.

STD



Add the new node at the end of the line. Remember to move the EOL to panel 4 OUT connection. Remember the overall cable length should not exceed 1.5km

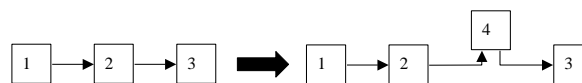

Add the new node at the most convenient point for the installation wiring. Break the wiring between the nodes (i.e. between nodes 2 / 3) and reconnect – see above. Remember the overall cable length should not exceed 1.5km

FT

Configure the new node on the network by giving it a unique node address in the same way as when the network was first commissioned (e.g. assign it to node 4, with next node set to 1)

Tell node 3 that its next node is now node 4.

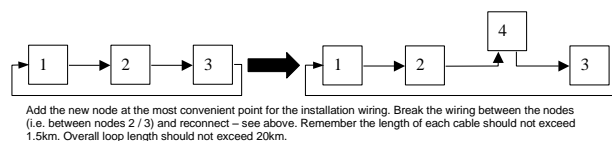
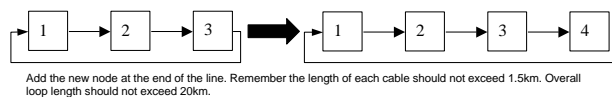

3.3 Making Changes to a Panel

If a change is made to one or more detectors on a panel, the new detectors should be “Auto Learnt” and the appropriate zone assignment and text added in the normal manner. Use either the panel keyboard or the PC configuration tool.

All other panels and display terminals on the network will be automatically informed when the panel is returned to Level 2 operation. If faults are present on any of the panels at the time the update is performed, the buzzer may re-sound and require muting once more.

3.4 Changing Time and Date

If the time or date needs to be altered, this can be performed from the most convenient panel. Just enter the Time/Date in the normal manner and then return the panel to normal Level 2 access – all commissioned panels on the network will then be synchronised to the same time and date.

Time clock synchronisation activity occurs several times each day. This ensures each panel’s event log is using the same time reference.

4 Diagnostics Tools

4.1 Fault Tolerant Network Card Software version

The version number of the firmware of the fault tolerant network card can be viewed. Navigate to the network diagnostics screen, and the version is shown in the upper right area of the screen, as shown below.

This software version information can also be viewed using the VIEW – PANEL – SOFTWARE menu option.

FT – Version information

```
[NETWORK - Press 0 to Clear] FT V04.00
Data Packets :      478234
Bad Packets  :           0
Comms Lost   :           0
FT Ring Fault:           0
Next Node at :           6
```

4.2 Printed Circuit Card Indicators

Each card incorporates LED Indicators that may be useful in diagnosing fault conditions on the network.

NOTE: Peripheral cards and Remote Terminals also include these LED Indicators as standard for their standard RS485 network interface.

There are two LED Indicators for Reception (RX) and Transmission (TX) of data into or out of the unit respectively. These flash according to whether data is being received or transmitted.

In addition, the Fault Tolerant Interfaces incorporate a third LED Indicator to provide additional diagnostic information on the performance of the network and on the performance of the Fault Tolerant Card itself.

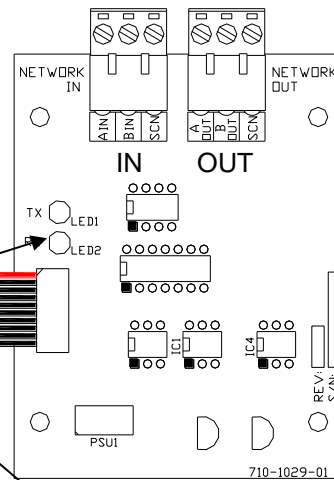

Standard Network Card – Panel

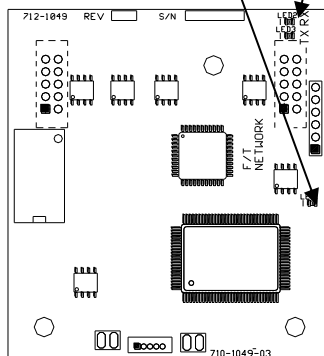

Fault Tolerant Network Card – Peripheral

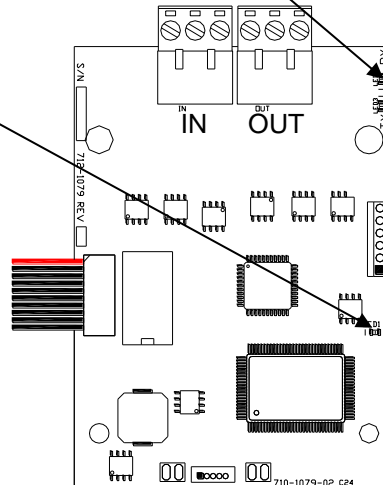

Fault Tolerant Network Card – Panel

4.3 Panel Network Analyser

Each panel has a network analyser built into the panel circuits and software. It's well worth using this analyser each time you add a new panel to the network. When you exit from commissioning, invoke the analyser by selecting from the "Level 2 Menu" / "VIEW" the "NETWORK" option.

The screen will then show a list of all network nodes. For example, if we have accessed the Network analyser from node 3 a typical normal display is shown below: -

(STD heads each screen example shown for a standard type network and FT for a fault tolerant network.)

STD

```
[NETWORK - Press 0 to Clear] More >
Node State
 1 LEVEL 1
 2 LEVEL 1
 3 LOCAL
 4 LEVEL 1
```

FT

```
[NETWORK - Press 0 to Clear] More >
Node State
 1 LEVEL 1 FT RING
 2 LEVEL 1 FT RING
 3 LOCAL FT RING
 4 LEVEL 1 FT RING
```

If a panel is not responding / cannot be found the following are typical displays: -

STD

```
[NETWORK - Press 0 to Clear] More >
Node State
 1 LEVEL 2
 2 -
 3 LOCAL
 4 LEVEL 3
```

FT

```
[NETWORK - Press 0 to Clear] More >
Node State
 1 LEVEL 2 FT RING
 2 -
 3 LOCAL FT RING
 4 LEVEL 3 FT RING
```

Node 1 is working at access level 2 (i.e. with all control keys enabled).

Node 2 is not responding on the network, so the state cannot be determined.

Node 3 shows "LOCAL" to indicate we are accessing the network from this panel.

Node 4 is at access level 3 (i.e. present on network, but still in commissioning mode).

The ↑ and ↓ scroll keys allow the display to scroll and see other nodes.

Certain fault messages are latched. Press RESET to clear these conditions.

Pressing the "0" key will clear all old diagnostic information.

4.3.1 Network Diagnostics – Duplicated Nodes

All node addresses on the network should be unique.

If a "NODE DUPLICATED" message is shown, this indicates that another node has been detected at the same node address. For example:

STD

```
[NETWORK - Press 0 to Clear] More >
Node State
 1 LEVEL 2
 2 LEVEL 2
 3 LOCAL NODE DUPLICATED
 4 LEVEL 1
```

FT

```
[NETWORK - Press 0 to Clear] More >
Node State
 1 LEVEL 2 FT RING
 2 LEVEL 2 FT RING
 3 LOCAL NODE DUPLICATED
 4 LEVEL 1 FT RING
```

4.3.2 Network Diagnostics – Duplicated Zones

A warning is produced if any of the panels that are active on the network appear to duplicate zones that have been assigned to this panel.

For example, if both this panel and the panel at node 2 both have devices assigned to zone 19, a “Duplicated Zone” warning is shown.

STD

```
[NETWORK - Press 0 to Clear] More >
Node State
 1 LEVEL 2
 2 LEVEL 2 CHECK DUPLICATED ZONE 0019
 3 LOCAL
 4 LEVEL 1
```

FT

```
[NETWORK - Press 0 to Clear] More >
Node State
 1 LEVEL 2 FT RING
 2 LEVEL 2 CHECK DUPLICATED ZONE 0019
 3 LOCAL FT RING
 4 LEVEL 1 FT RING
```

There are no restrictions to the order in which zones are assigned.

For example, it is OK for Node 1 to have devices in zones 31, 32 and 35, and Node 2 to have devices in zone 1, 2, 33 and 34.

4.3.3 Network Diagnostics – Additional Fault Tolerant Information

The Fault Tolerant Network provides additional information to locate the source of any network wiring failures.

The example below show that there is: -

- A) A fault on the input to Node 2. For example, an open or short circuit cable could cause this condition.

```
[NETWORK - Press 0 to Clear] More >
Node State
 1 LEVEL 2 FT RING FAULT
 2 LEVEL 2 FT RING INPUT LOST
 3 LOCAL FT RING FAULT
 4 LEVEL 1 FT RING FAULT
```

The network diagnostic function periodically checks that it is possible to transmit and receive in the opposite direction. If there is a fault in the hardware, a ‘REVERSE RING FAULT’ will be shown. This is particularly important for fibre networks – see below.

4.3.4 Network Diagnostics – Fibre Networks

Faults in systems that consist of one or more fibre optic links can be identified as described previously in the network diagnostics section, with the exception of one category of fault that is peculiar to fibre optic links. This particular type of fault is where a condition exists that prevents data passing from the "IN" terminal of one node to the "OUT" terminal of the connected node, but data flow in the opposite direction is unimpeded.

Such a condition can typically arise when fibre optic links are used, and is illustrated in the figure above. The system shown has a single break in the fibre optic cable between the transmit output of the fibre interface connected to node 4 and the receive input of the fibre interface connected to node 3. Here data is prevented from passing from the "IN" terminal of node 4 to the "OUT" terminal of node 3, but is unaffected in the opposite direction.

A network fault will be detected on the system in such an instance but the location of the fault cannot be exactly determined. A suggested list of possible fault positions can however be seen using the network analyser screen.

The rule is that if such a fault exists then "FT REVERSE RING FAULT" will be shown on node 1 and all other nodes between it and the node that actually has the fault on its "IN" terminal, working in the direction from "IN" terminal of node 1 to the "OUT" terminal of the node that this is connected to. It is helpful to have a site wiring plan to aid in locating these faults.

For the fault shown in the example above, panels would show the following information:

FT

```
[NETWORK - Press 0 to Clear] More >
Node State
 1 LEVEL 2 FT REVERSE RING FAULT
 2 LEVEL 2 FT REVERSE RING FAULT
 3 LOCAL FT RING
 4 LEVEL 1 FT REVERSE RING FAULT
```



```
[NETWORK - Press 0 to Clear] More >
Node State
 49 -
 50 LEVEL 2 FT REVERSE RING FAULT
 51 LEVEL 3 FT RING
 52 -
```

If the fibre link between the transmit output of the fibre interface connected to node 3 "OUT" and the receive input of the fibre interface connected to node 4 "IN" is also broken, so there is no fibre connection between the two interfaces, then the system will report the fault in the conventional manner. The network view will then be as shown below.

FT

```
[NETWORK - Press 0 to Clear] More >
Node State
 1 LEVEL 2 FT RING FAULT
 2 LEVEL 2 FT RING FAULT
 3 LOCAL FT RING FAULT
 4 LEVEL 1 FT RING INPUT LOST
```



```
[NETWORK - Press 0 to Clear] More >
Node State
 49 -
 50 LEVEL 2 FT RING FAULT
 51 LEVEL 3 FT RING FAULT
 52 -
```

4.3.5 Network Diagnostics – Statistical Analysis

Pressing the "⇐⇒" key will change the display format to a statistical mode. It shows the number of data packets passing over the network and the number of errors detected in the packets.

Note that major network errors, such as the complete loss of a node from a network, are reported on the previous screens (and on the standard panel fault displays). This statistical view is intended for indicating the occurrence of occasional interference, etc.

Pressing the "0" key will clear any old data out before using this display for the first time.

STD

```
[NETWORK - Press 0 to Clear]
Data Packets : 478234
Bad Packets : 2
Comms Lost : 1
Next Node at : 6
```

FT

```
[NETWORK - Press 0 to Clear]
Data Packets : 478234
Bad Packets : 2
Comms Lost : 1
FT Ring Fault: 1
Next Node at : 6
```

On a healthy network, the number of Data Packets will rapidly increase – several million will be sent each day.

The network is intended to function normally with an occasional Bad Packet, but if this number is seen to increase at a rate of several per hour or higher, it indicates that the network has to deal with continuous corruptions. This may result in delays in the reporting of alarms. The most likely cause is interference from an external source – also check that screen terminations have been made correctly. Address the problem as soon as possible.

A "NETWORK NOISY" message on the normal user display indicates that the network is having difficulty in transmitting messages around the network. Use the diagnostics tools and recommendations above to establish the cause of this problem. NOTE: This message may also be shown for a short period after a true network wiring fault has been cleared (usually <30 seconds).

If the "NEXT NETWORK NODE" address is different to that entered during network configuration, then this node has been unable to communicate with its neighbour. It will then attempt to search out and find another active node on the network. If no other nodes can be found, this will then revert to its own node address.

5 Common Faults / Problems

5.1 *Corruption in the Transmission of Data*

The most likely reason is that the cabling is being subjected to external interference. This can be caused by a number of factors. For example:

Non-screened cable used.

Re-route the cable or consider changing to screened cable

Cable Screen not correctly terminated.

Ensure that the cable screen is connected to the SCN terminal on the connector.

Cables connected to the wrong terminal block.

Check that the cables are connected IN to OUT throughout and there are no cables connected IN to IN or OUT to OUT.

6 Recommended Cables

A 2-core twisted-pair cable is required between each Ad-Net node. Choose a cable in accordance with the regulations and codes appropriate to the country and location of installation. The following is recommended if no other regulations apply.

6.1 Fire rated cable

Manufacturer	Model	Cable Type
Huber & Suhner	Radox	Screened Twisted Pair Fire Cable Type FR BS/M 1 x 2 x 1.5mm ²
Pirelli	FP200 Gold	Screened Twisted Pair (5 twists/metre) 1.0mm ²
Pirelli	FP200 Flex	Screened Twisted Pair (9 to 10 twists/metre) 1.0mm ²
AEI	Firetec	Screened Twisted Pair (20 twists/metre) 1.0mm ²
Draka	Firetuf	Screened Twisted Pair FTZ 2E 1.0 (1.0mm ² solid) or FTZ 2E7 1.0 (1.0mm ² stranded)
AEI	Firetec MI	Two Core 16AWG cable ref: 2-16-340 *
Tyco Thermal Controls	Pyro E (MICC)	Screened Twisted Pair CCM2T1 (1.0mm ²) or CCM2T1.5 (1.5mm ²)

6.2 Non-Fire rated cables

Manufacturer	Model	Cable Type
Belden	8205	Unscreened Twisted Pair 20 AWG (0.5 mm ²)
Belden	8461	Unscreened Twisted Pair 18 AWG (0.8mm ²)
Belden	8760	Screened Twisted Pair 18 AWG (0.79mm ²)
Belden	8762	Screened Twisted Pair 20 AWG (0.56mm ²)
Alpha & BICC	Alpha 2421, BICC H8093	Screened Twisted Pair 18 AWG Type 2
Alpha & BICC	Alpha 2411, BICC H8091	Screened Twisted Pair 20 AWG Type 2
Belden	9802	Screened Twisted Pair 20 AWG Type E buried distribution wire **

* Not twisted pair – route away from mains voltages.

** Twisted pair cable suitable for use underground (NB NOT SINGLE WIRE ARMoured).