

MHUB U (4x3+1)

Product code: MHUB431U40

UK: 2.50.839 AU: 2.50.846

EU: 2.50.844 US: 2.50.845

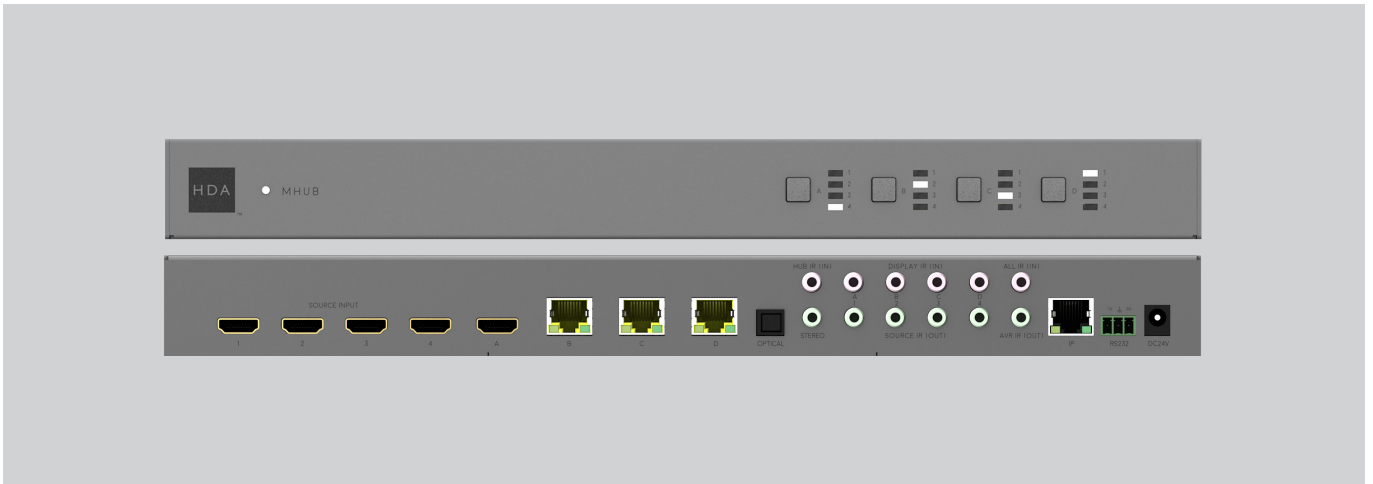

Cloud monitorable 4x3+1 HDMI/HDBT+HDMI matrix system with a 40m UHD 4K or 70m 1080p transmission range. An integrated IP>IR control processor enables property-wide control of all the connected sources and displays via the free uControl universal remote App or Alexa voice commands.

Multichannel audio or stereo extraction can be selected to match any of the display zone outputs A,B,C or D.

Features

HDMI® 2.0 features supported up to 18Gbps
All display receivers powered via PoH
IR over HDMI injector dongle included
Web GUI for easy config and setup (MHUB-OS)
Remote system monitoring (HDA Cloud)
Advanced EDID management
Supports source content up to and inc. Ultra HD 4K 60 4:4:4 with High Dynamic Range (HDR) formats inc. Dolby Vision®
Supports all current audio formats up to and including Dolby Atmos® and DTS:X®
Multichannel audio or stereo extraction via digi-coax, or via 3.5mm stereo jack
4K>1080 down/up-scaling receiver option available
Sold as a complete install package, with all receivers and IR cables.
Rack mounting kit sold separately

Specification

Form factor	Compact unit. Rack-mountable with optional 19"/1U kit (1.85.910.002.1)
Inputs x outputs	4 HDMI x 3 RJ45 HDBaseT + 1 HDMI
Transmission tech.	HDBaseT (VS010) + TPC and HDMI
Video bandwidth	HDMI backplane 594MHz clock / 18Gbps data HDBT 340MHz clock / 10.2Gbps data
ESD protection	± 8kV (air-gap discharge) ± 4kV (contact discharge)
Hub control	Web GUI, IR, TCP/IP, RS232, App, Alexa
App control	Full control over sources, matrix hub & display functions.
Device weight	Hub 1900g RX 125g
Package weight	2500g
Dimensions (W/D/H)	Hub 372 / 167 / 36mm (without feet) RX 140 / 65 / 17mm
Operating temperature	32°F to 104°F (0°C to 40°C)
Storage temperature	-4°F to 140°F (-20°C to 60°C)
Relative humidity	20~90 % RH (non-condensing)
Power consumption	30W (max) 0.5W (standby)
Guarantee	2/3-year guarantee (Cloud registration required)

Control



App control
Full control of your MHUB, Source and Displays via our integrated and free app, uControl.



Voice Control
All MHUB's support Amazon Alexa natively, allowing full control of your AV system using voice commands.



3rd Party Control
MHUB's offer IP and RS232 integration as standard. Advanced "Expanded I/O" drivers also supported for major control systems.



IR Control
One infrared (IR) remote controller included for hub and zone control inside package.

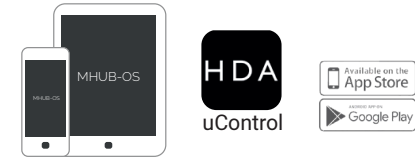
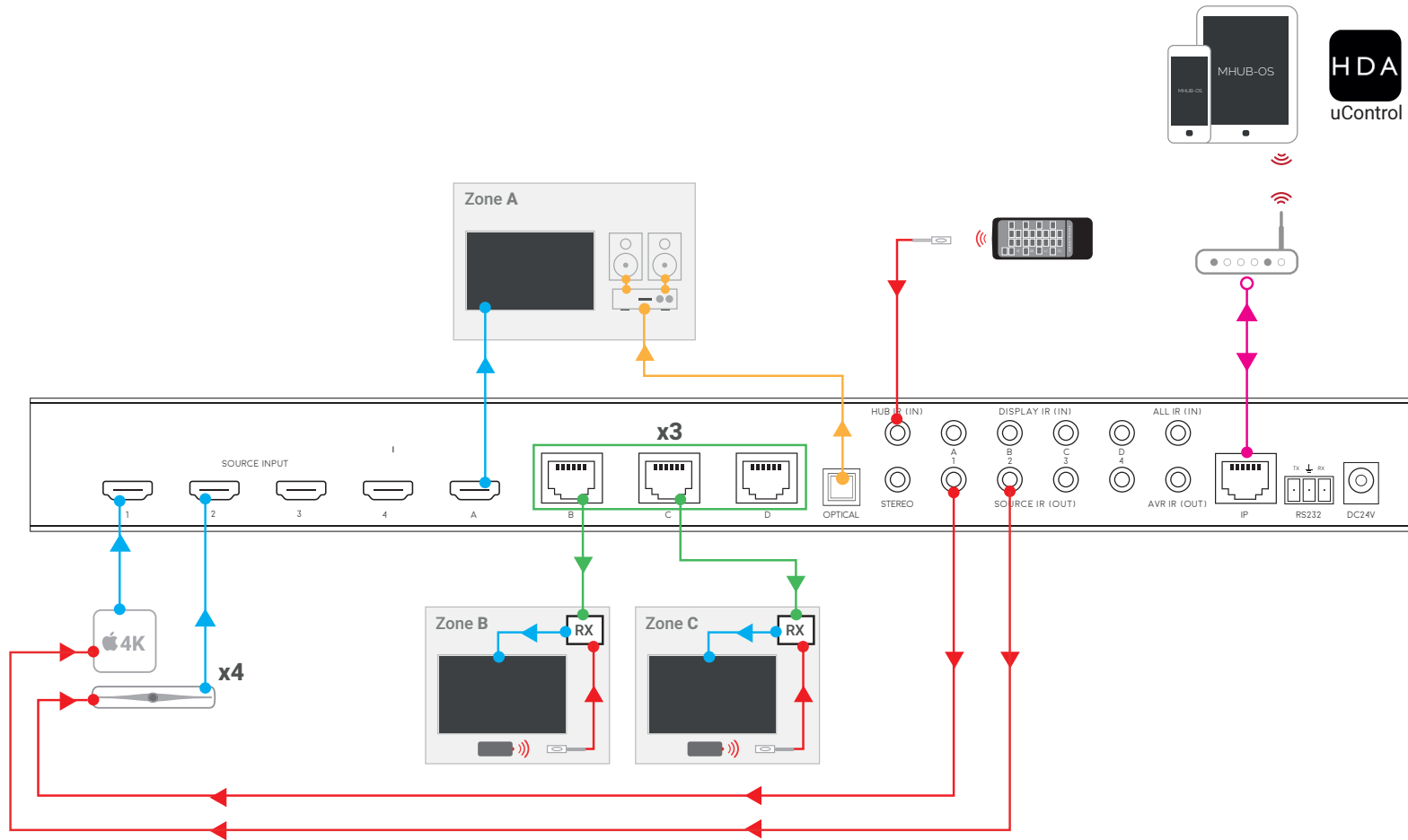

LEGEND

- Ethernet Cable
- HDMI Cable
- TOSLink Cable
- IR Cable
- Cat Cable
- IR Receiver
- IR Signal

HDANYWHERE.COM

Hereby, HDANYWHERE™ declares that this HDMI connectivity device is in compliance with the essential requirements and other relevant provisions of the following Directives: 2006/95/EC (LVD Directive); 2004/108/EC (EMC Directive); 999/5/EC (R&TTE Directive).
 HD CONNECTIVITY LTD, trading as HDANYWHERE registered in England and Wales. Company No: 06046737 Registered office: Unit 23 Link Business Centre, Link Way, Malvern, Worcestershire, WR14 1UG. Contact: support@hdanywhere.com Tel: 00441684575324